



USER MANUAL



SGC 410 Single Genset Controller



1. Introduction	
1.1 About SGC 410	4
1.2 Key functions	4
1.3 Product overview	4
1.4 Passwords	5
1.5 Overview of controller buttons	5
1.6 Legal information	6
2. Safety instructions	
2.1 General safety instructions	7
2.2 Electrical safety	7
2.3 In operation safety	7
3. Technical specifications	
3.1 Terminals	8
3.2 Power supply	8
3.3 Genset voltage and frequency measurements	9
3.4 Genset current measurements	9
3.5 Earth leak measurements	9
3.6 Digital inputs	10
3.7 Analogue resistive sensor inputs	10
3.8 Analogue inputs used as digital inputs	11
3.9 Site battery inputs	11
3.10 Magnetic pick-up (MPU) input	11
3.11 Digital outputs	12
3.12 D+ Charger alternator	12
3.13 Sensor common point	12
3.14 Communication ports	13
4. Installation	
4.1 Dimensions	14
4.2 Mounting in panel	14
4.3 Terminal details	15
4.4 Typical wiring diagram	17
5. Monitoring mode	
5.1 Monitoring mode	18
6. Configuration mode	
6.1 Configuration mode	20
6.2 Configurable parameters	20
6.2.1 Configurable parameters	20
6.2.2 Module	21
6.2.3 Digital inputs	23
6.2.4 Analogue inputs	23
6.2.5 Outputs	30
6.2.6 Timers	30
6.2.7 Generator	31
6.2.8 Mains	34
6.2.9 Engine	35
6.2.10 Maintenance	38
6.2.11 Password ID	38

6.3 Digital input source selection.....	39
6.4 Digital output source selection.....	39
7. Running modes	
7.1 Auto mode.....	42
7.2 Manual mode.....	43
7.3 Start and stop sequences.....	45
8. Load detection	
8.1 Load detection in Auto mode.....	47
8.2 Load detection in Manual mode.....	47
9. Features	
9.1 About Features.....	48
9.2 Auto config exit mode.....	48
9.3 Load histogram.....	48
10. Alarms	
10.1 Alarms.....	49
11. Modbus communication protocol	
11.1 About the Modbus communication protocol.....	53
11.2 Modbus connection details.....	53
11.3 Modbus functions.....	53
12. Modbus communication settings	
12.1 Modbus communication settings.....	54
12.2 Register map (function code 03).....	54
12.3 Register map (function code 16).....	61
13. Engine communication	
13.1 Introduction to engine communication.....	62
13.2 Default settings.....	62
13.3 Supported engines.....	62
13.4 Engine values on the display.....	62
13.5 Engine communication settings.....	63
13.6 Generic J1939.....	64
13.7 Wiring.....	65
14. CAN communication	
14.1 About the CAN communication protocol.....	66
14.2 CAN communication structure.....	66
14.3 CAN packet structure.....	76
15. Troubleshooting	
15.1 Troubleshooting.....	77

1. Introduction

1.1 About SGC 410

SGC 410 is a modern genset controller with user friendly HMI, full graphics LCD, and a highly versatile software. Extensive inputs and outputs support a wide variety of industry standard features in diesel/gasoline genset applications.

SGC 410 offers Site battery monitoring which significantly reduces fuel consumption. The controllers support Shelter temperature monitoring, Auto (Remote start /stop, Cyclic and Exercise mode), Manual and Test modes.

The DEIF Smart Connect software offers flexibility to configure each individual input and output for a specific function or application. All parameters can also be configured on the controller.

The powerful micro controller in SGC 410 supports a range of complex features, for example:

- LCD display
- True RMS voltage and current monitoring
- RS-485 base communication
- Monitoring of engine and alternator parameters
- Configurable inputs and outputs for a wide range of functions

1.2 Key functions

- Genset controller with configurable inputs:
 - Nine digital inputs
 - Eight analogue inputs (configurable as digital inputs)
- Seven digital outputs
- Auto (Site battery backup, Remote start/stop, Cyclic and Exercise) modes, Manual and Test modes
- Site battery monitoring
- Shelter temperature monitoring
- Real time clock
- Fuel theft alarm
- Cyclic timer
- RPM sensing using genset's output frequency
- Backlit full graphics display

1.3 Product overview

Features	Specifications
Digital switch input	9
Analogue resistive inputs	5
Analogue current/voltage inputs	2
Differential input (± 60 V DC) for Site battery voltage	Yes
DG alternator voltage input, D+ charging alternator I/O	Yes
Digital outputs	7
Event logs	Yes
USB port for PC based configuration	Yes
RS-485 for Modbus communication	Yes
Operating battery supply voltage (with -32 V reverse protection)	8 to 32 V DC

Features	Specifications
Operating temperature range (°C)	-20 to 65
Protection class with gasket (included)	IP65
Warning auto clear enable/disable	Yes
Fuel reference selection input	Yes









1.4 Passwords

The controller is protected from set-up changes with a four digit password.

There are two password levels:

Level	Access	Factory setting
1	Full access (read and write)	0123
2	Limited access (read)	1111

The passwords can be changed on the controller:

1. Go to Configuration mode.
2. Log on with password level 1.
3. Use the Up  and Down  buttons to go to Configuration ID, select with the Start  button.
4. Use the Up  and Down  buttons to go to the password to be changed, select with the Start  button.
5. Use the Up  and Down  buttons to choose the first digit for the new password, select with the Start  button.
6. Repeat for the next three digits.
7. When all four digits are chosen, the display shows

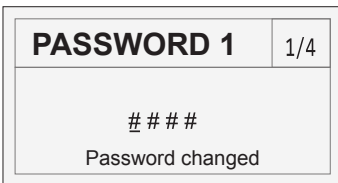

1.5 Overview of controller buttons

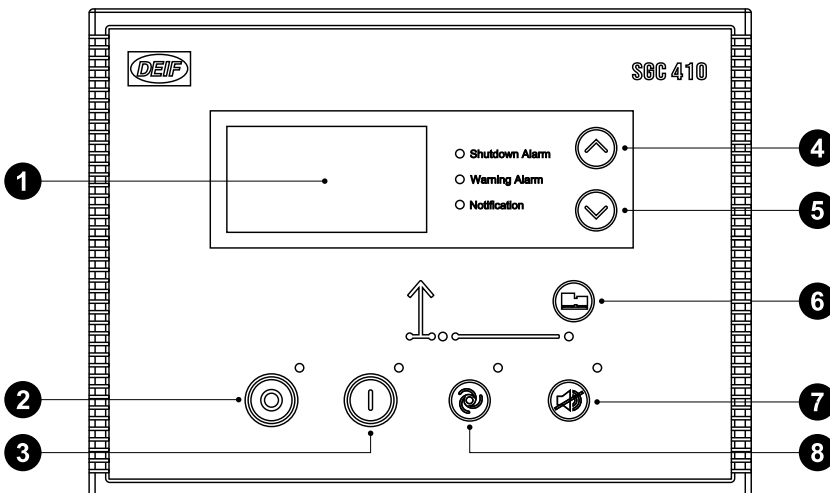

1. Display
2. Stop/Config button
3. Start button
4. Menu navigation up button
5. Menu navigation down button
6. Genset contactor latching button
7. Acknowledge button
8. Mode selection button

1.6 Legal information

Warranty



WARNING

The controller is not to be opened by unauthorised personnel. If the controller is opened anyway, the warranty will be lost.

Disclaimer

DEIF takes no responsibility for installation or operation of the generator set. If there is any doubt about how to install or operate the engine/generator controlled by the SGC controller, the company responsible for the installation or the operation of the set must be contacted.

DEIF A/S reserves the right to change any of the contents of this document without prior notice.

The English version of this document always contains the most recent and up-to-date information about the product. DEIF does not take responsibility for the accuracy of translations, and translations might not be updated at the same time as the English document. If there is a discrepancy, the English version prevails.

Copyright

© Copyright DEIF A/S 2020. All rights reserved.

2. Safety instructions

2.1 General safety instructions

This document includes important instructions that should be followed during installation and maintenance of the controller.

Installation and maintenance must only be carried out by authorised personnel, and always in accordance with all applicable state and local electrical codes. Efficient and safe operation of the controller can be acquired only if the equipment is correctly operated, configured and maintained.

The following notations found in this document can indicate potentially hazardous conditions to the operator, service personnel or the equipment.

NOTE Highlights an essential element of a procedure to ensure correctness.



CAUTION

Indicates a procedure or practice, which could result in damage or destruction of equipment, if not strictly observed.



WARNING

Indicates a procedure or practice, which could result in injuring personnel or loss of life, if not followed correctly.

2.2 Electrical safety

- Electric shock can cause severe personal injury or death.
- Ensure that the genset is grounded before performing any installation or service.
- Generators produce high electrical voltages, and direct contact with it can cause fatal electrical shock. Prevent contact with terminals, bare wires, connections, etc., while the generator and related equipment are running. Do not tamper with interlocks.
- To handle the maximum electrical current, the wires used for electrical connections and wirings must be of appropriate size.

2.3 In operation safety

- Before installing the controller, ensure that all power voltage supplies are positively turned off at the source. Disconnect the generator's battery cables and remove the panel fuse to prevent accidental start up. Disconnect the cable from the battery post, indicated by a NEGATIVE, NEG, or (–) first. Reconnect the negative cable last. Failure to do so will result in hazardous and possibly fatal electrical shock.
- Remove the electric power supply before removing the controller or touching other electrical parts.
- Use extreme caution when working on electrical components. High voltage can cause injury or death.
- With floors of metal or concrete, use rubber insulation mats placed on dry wood platforms when working near the generator or other electrical equipment.
- Do not wear damp clothing (particularly wet shoes) or allow skin surface to be damp when handling electrical equipment.
- Do not operate any electrical device or wires while standing in water, while barefoot, or while hands or feet are wet. It may result in severe electrical shock.
- Do not wear jewellery. Jewellery can cause a short circuit within electrical contacts and cause shock or burning.

In case of an accident caused by electric shock, immediately shut down the electrical power source. If this is not possible, try to release the victim from the live conductor. Avoid direct contact with the victim. Use a non-conducting object (for example a rope or a wooden stick) to release the victim from the live conductor. If the victim is unconscious, apply first aid and get immediate medical help.

3. Technical_specifications

3.1 Terminals

The SGC 410 uses two types of terminal blocks:

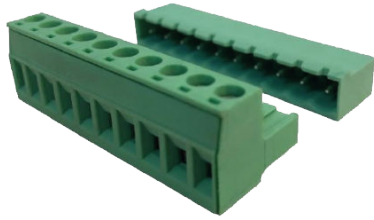

Connectors of 5.08 mm pitch

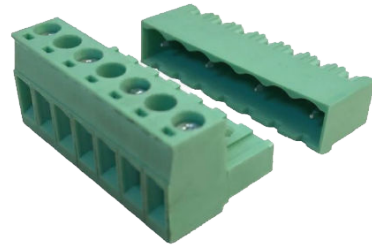

Connectors of 10.16 mm pitch

Table 3.1 Terminals

Connector type	Pitch	Male (on controller)	Female (mating part)	Quantity
3-pin	5.08 mm	5447366	5441977	1
4-pin	5.08 mm	5447379	5448637	1
5-pin	5.08 mm	5447382	5448640	1
6-pin	5.08 mm	5441919	5441964	1
8-pin	5.08 mm	5441935	5441951	1
9-pin	5.08 mm	5447395	5448653	1
10-pin	5.08 mm	5447405	5448666	1
4-pin	10.16 mm	5474274	5453499	2

3.2 Power supply

Category	Specification
Controller terminals	1 (Ground) 2 (Battery or DC+)
Supply voltage range	Nominal voltage: 12/24 VDC Operating range: 8 to 32 V DC
Cranking drop out period	50 ms
Maximum reverse voltage protection	-32 V DC
Measurement accuracy (battery voltage)	±1 % full scale
Resolution	0.1 V
Maximum current consumption	~ 200 mA, 12/24 V DC (excluding the current load for the DC outputs)
Standby current consumption	180 mA, 12 V DC 140 mA, 24 V DC

3.3 Genset voltage and frequency measurements

Category	Specifications
Controller terminals	54 (Neutral) 55 (L3) 56 (L2) 57 (L1)
Measurement type	True RMS
Phase-to-neutral voltage	32 to 300 V AC RMS
Phase-to-phase voltage	32 to 520 V AC RMS
Voltage accuracy	±1 % of full scale for phase-to-neutral ±1.5 % of full scale for phase-to-phase
Voltage resolution	1 V AC RMS for phase-to-neutral 2 V AC RMS for phase-to-phase
Frequency range	5 to 75 Hz
Frequency accuracy	0.25 % of full scale
Frequency resolution	0.1 Hz

NOTE For single phase applications, it is mandatory to connect the genset phase and neutral cables to the genset controller's phase L1 and neutral terminals.

3.4 Genset current measurements

Category	Specifications
Controller terminals	43 and 42 (for phase L1) 45 and 44 (for phase L2) 47 and 46 (for phase L3)
Measurement type	True RMS
Maximum CT secondary current rating	5 A
Burden	0.25 VA
Measurement accuracy	±1.4 % of nominal

3.5 Earth leak measurements

Category	Specifications
Controller terminals	48 and 49
Measurement type	True RMS
Maximum CT secondary current rating	5 A
Burden	0.25 VA
Measurement accuracy	±1.4 % of nominal

NOTE Follow the recommended phase sequence while connecting the current transformer (CT).

3.6 Digital inputs

Category	Specifications
Controller terminals	33, 34, 35, 36, 37, 38, 39, 40, 41
Number of inputs	9
Type	Negative sensing (connect to ground for activation)
Software configurable options	Emergency stop, Remote start/ stop, and more (see Controller overview, Configurable parameters in the User manual for more details).

3.7 Analogue resistive sensor inputs

Category	Specifications
Controller terminals	11 (Oil pressure) 12 (Fuel) 13 (Temperature) 14 (Aux 1) 15 (Aux 2)
Number of inputs	5
Type	Ratio-metric sensing
Range	10 to 5000 Ω
Open circuit detection	Above 5.5 k Ω
Measurement accuracy	$\pm 2\%$ of full scale (up to 1000 Ω)

SCP connection

SCP connections for Analogue inputs 1 to 4*:

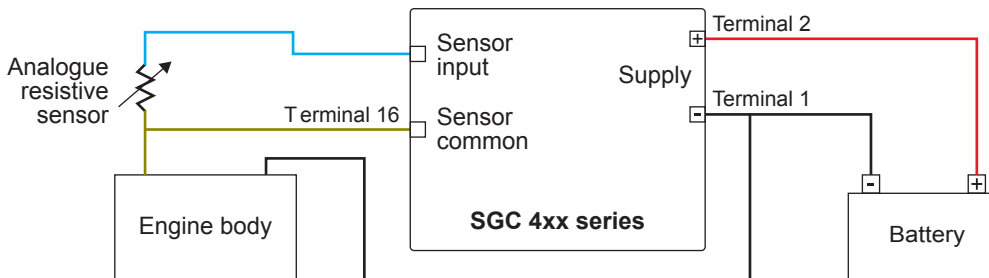

*SCP connections for Analogue input 2 used as *Fuel level sensor* with the reference configured as *Battery Negative*

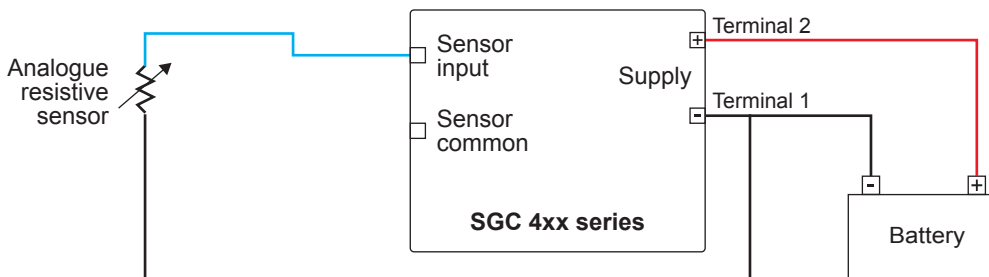

3.8 Analogue inputs used as digital inputs

Analogue inputs can be used as digital inputs when wired as shown.

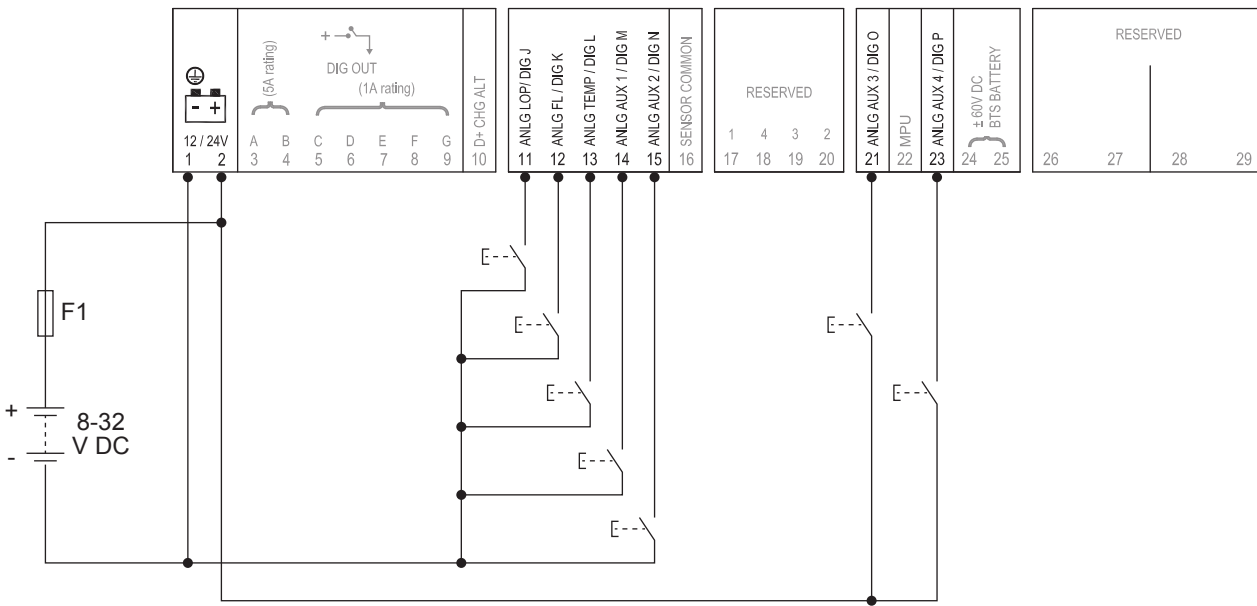

3.9 Site battery inputs

Category	Specifications
Controller terminals	24, 25
Number of inputs	2
Type	Differential
Range	±60 V
Resolution	0.1 V
Accuracy	±2 % of full scale

Site battery run hours

In this feature, controller calculates the run hours for which the site runs on the battery backup. Site battery run hours are incremented only when the genset contactors are not latched and when site battery voltage is greater than low battery voltage threshold.

3.10 Magnetic pick-up (MPU) input

Category	Specifications
Controller terminal	22
Measurement type	Single ended
Frequency range	10 to 10 kHz
Input voltage range	200 mV to 45 V AC RMS

The Magnetic pick-up (MPU) is an inductive sensor fitted on the engine flywheel for the engine speed sensing. The output of the MPU is a sine-wave signal.

3.11 Digital outputs

Category	Specifications
Controller terminals	3, 4, 5, 6, 7, 8, 9
Number of outputs	7
Type	DC outputs
Maximum current rating	5 A (3 and 4) 1 A (5, 6, 7, 8, 9)
Software configurable options	Start relay, Fuel relay, Close genset contactor, Stop solenoid and many more (see Controller overview, Configurable parameters in the User manual for more details).

- NOTE**
- Do not connect the Starter motor relay and the Stop solenoid directly to the controller's output terminals. It is recommended to connect terminals 3 and 4 to Start and Stop.
 - Genset contactor latching relays should be compiled against 4 kVA surge as per IEC-61000-4-5 standard.

3.12 D+ Charger alternator

Category	Specifications
Controller terminal	10
Voltage range	0 to V_{BATT} $V_{BATT} = 8$ to 32 V DC
Excitation	PWM (power limited to 3 W, 12 V/250 mA, 24 V/125 mA)
Accuracy	± 2 % of full scale

The charge fail is a combined input and output terminal. When the genset starts, the terminal provides controlled power output to excite the charging alternator. After the excitation is successfully done, the controller reads the charging alternator's output voltage for monitoring its health. The action for charge fail is configurable.

3.13 Sensor common point

Category	Specifications
Controller terminal	16
Range	± 2 V
Accuracy	± 2 % of full scale

The sensor common point (SCP) terminal 16 must be connected directly to an electrically sound point on the engine body. This point serves as a common reference point for all analogue sensors. The electrical cable used for the connection must not be shared with any other electrical connection. This wiring practice is strongly recommended to ensure that there is negligible potential difference between the engine body and the controller's SCP terminal, and that predictable and accurate analogue sensor measurements are always available in a wide variety of field conditions.

3.14 Communication ports

Category	Specifications
USB	USB 2.0 type B for connection to PC with DEIF Smart Connect software
RS-485 Serial Port	Half Duplex Max. Baud Rate 115200 Data connection 2-wire Termination resistor of 120 Ω is provided between output terminals A and B Common-mode operating range Maximum distance of line is 200 m
Controller terminals	30 (GND) 31 (A) 32 (B)
CAN	Baud rate: 250 kbps Packet size: 8 bytes Termination resistor of 120 Ω is provided
Controller terminals for CAN	58 and 59

- NOTE**
- The RS-485 port on the controller supports a protocol based on Modbus.
 - Use two core shielded twisted pair cable for Modbus RS-485 connection.
 - Terminal 30 should be connected to master's isolated ground only.
 - Keep terminal 30 connection open if shielded cable is not available.
 - Do not connect terminal 30 to the negative battery terminal (DC -).

4. Installation

4.1 Dimensions

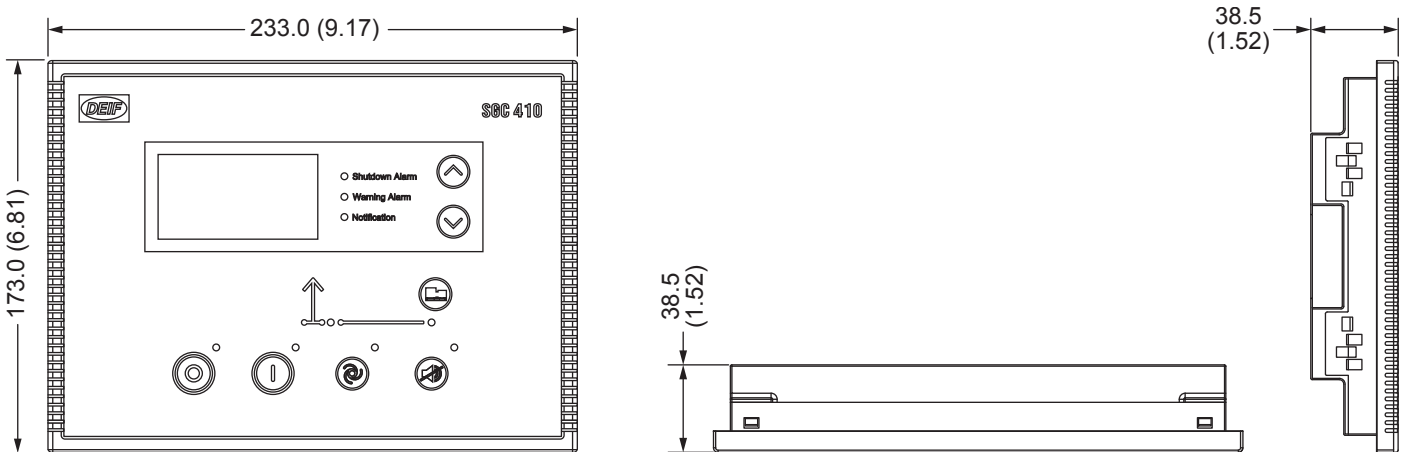

Dimensions

Dimensions	Length: 233.0 mm (9.17 in) Height: 173.0 mm (6.81 in) Depth: 38.5 mm (1.52 in)
Panel cut-out	Length: 219.0 mm (8.62 in) Height: 158.0 mm (6.22 in) Tolerance: ± 0.3 mm (0.01 in)

4.2 Mounting in panel

To mount the controller into the panel, use the fixing clips provided along with the controller.

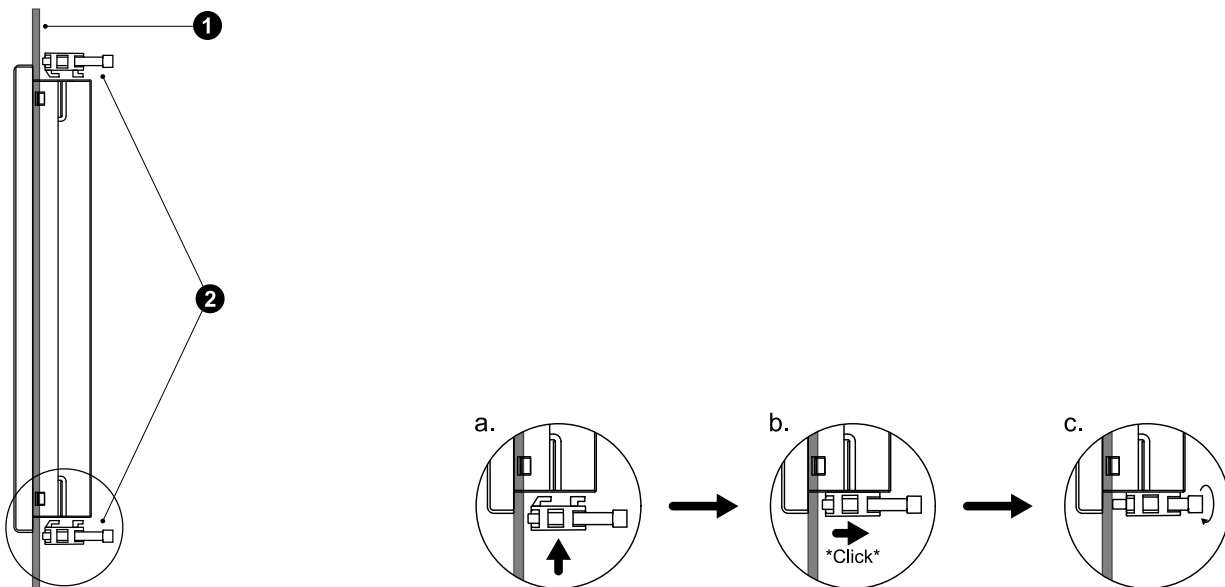

1. Panel surface.
2. Mounting clips.

- a. Insert the mounting clips into the slots on the controller.
- b. Press the mounting clips backwards until they "click" in place.
- c. Turn the screws to tighten the mounting clips (max. torque: 0.19 Nm).



CAUTION

Over-tightening the screw may damage the controller casing.

4.3 Terminal details

Rear view of the controller with terminal details.

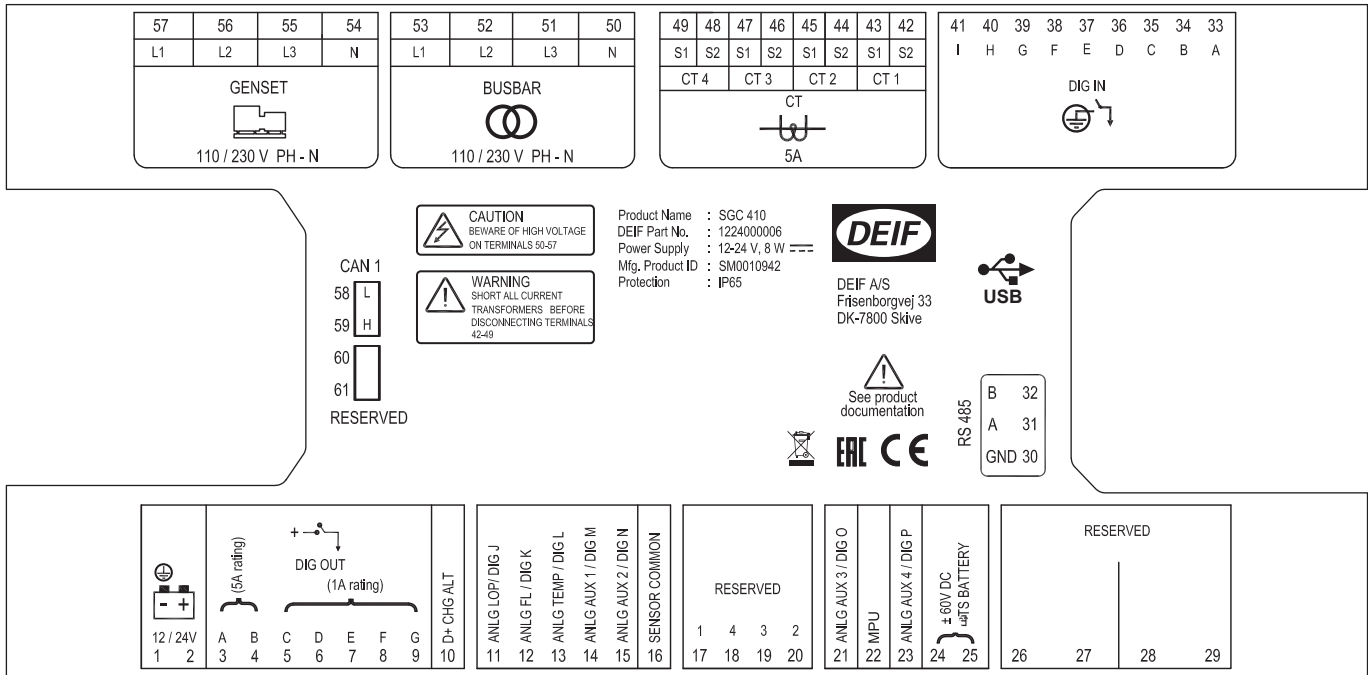

Terminal	Text	Description	Connector
1	GND	Power ground	BCP-508-10GN
2	BATT +	Power supply positive	
3	DIG OUT A	DC output - A	
4	DIG OUT B	DC output - B	
5	DIG OUT C	DC output - C	
6	DIG OUT D	DC output - D	
7	DIG OUT E	DC output - E	
8	DIG OUT F	DC output - F	
9	DIG OUT G	DC output - G	
10	D+ CHG ALT	Input for charging alternator control	
11	ANLG LOP / DIG J	Analogue input from Lube Oil Pressure Sensor/ Digital Input J	BCP-508-6GN
12	ANLG FUEL LEVEL / DIG K	Analogue input from Fuel Level Sensor/Digital Input K	
13	ANLG ENG TEMP / DIG L	Analogue input from Engine Temperature Sensor/ Digital Input L	
14	ANLG AUX 1 / DIG M	Analogue input auxiliary/Analogue input from Shelter Temperature Sensor/Digital Input M	
15	ANLG AUX 2 / DIG N	Analogue input auxiliary/Digital Input N	
16	SCP	Sensor common point	
17	Reserved	-	N/A
18	Reserved	-	N/A
19	Reserved	-	N/A

Terminal	Text	Description	Connector
20	Reserved	-	N/A
21	ANLG AUX 3/DIG 0	Analogue input auxiliary/0-5 V/4-20 mA (LOP)/ Digital Input O	BCP-508-5GN
22	MPU	Input from engine speed sensor (Inductive)	
23	ANLG AUX 4/DIG P	Analogue input auxiliary/0-5 V/4-20 mA/Digital Input P	
24	Site BATT I/P	Input 1 from Site battery	
25	Site BATT I/P	Input 2 from Site battery	
26	Reserved	-	
27	Reserved	-	N/A
28	Reserved	-	N/A
29	Reserved	-	N/A
30	RS 485 GND	RS-485 GND	BCP-508-3GN
31	RS 485 A	RS-485 A	
32	RS 485 B	RS-485 B	
33	DIG IN A	Input from switch A	BCP-508-9GN
34	DIG IN B	Input from switch B	
35	DIG IN C	Input from switch C	
36	DIG IN D	Input from switch D	
37	DIG IN E	Input from switch E	
38	DIG IN F	Input from switch F	
39	DIG IN G	Input from switch G	
40	DIG IN H	Input from switch H	
41	DIG IN I	Input from switch I	BCP-508-8GN
42	GEN CT IN L1-2	CT input 2 from Phase L1	
43	GEN CT IN L1-1	CT input 1 from Phase L1	
44	GEN CT IN L2-2	CT input 2 from Phase L2	
45	GEN CT IN L2-1	CT input 1 from Phase L2	
46	GEN CT IN L3-2	CT input 2 from Phase L3	
47	GEN CT IN L3-1	CT input 1 from Phase L3	
48	GEN CT IN EL2	CT input 2 from Earth Leakage	
49	GEN CT IN EL1	CT input 1 from Earth Leakage	BCP-508-7GN-4PA
50	Reserved	-	
51	Reserved	-	
52	Reserved	-	
53	Reserved	-	
54	GEN V N	Voltage input from Gen Neutral	
55	GEN V L3	Voltage input from Gen L3	
56	GEN V L2	Voltage input from Gen L2	
57	GEN V L1	Voltage input from Gen L1	

Terminal	Text	Description	Connector
58	CAN L (Reserved)	CAN Low	BCP-508-4GN
59	CAN H (Reserved)	CAN High	
60	Reserved	-	
61	Reserved	-	

4.4 Typical wiring diagram

Figure 4.1 SGC 410 typical wiring

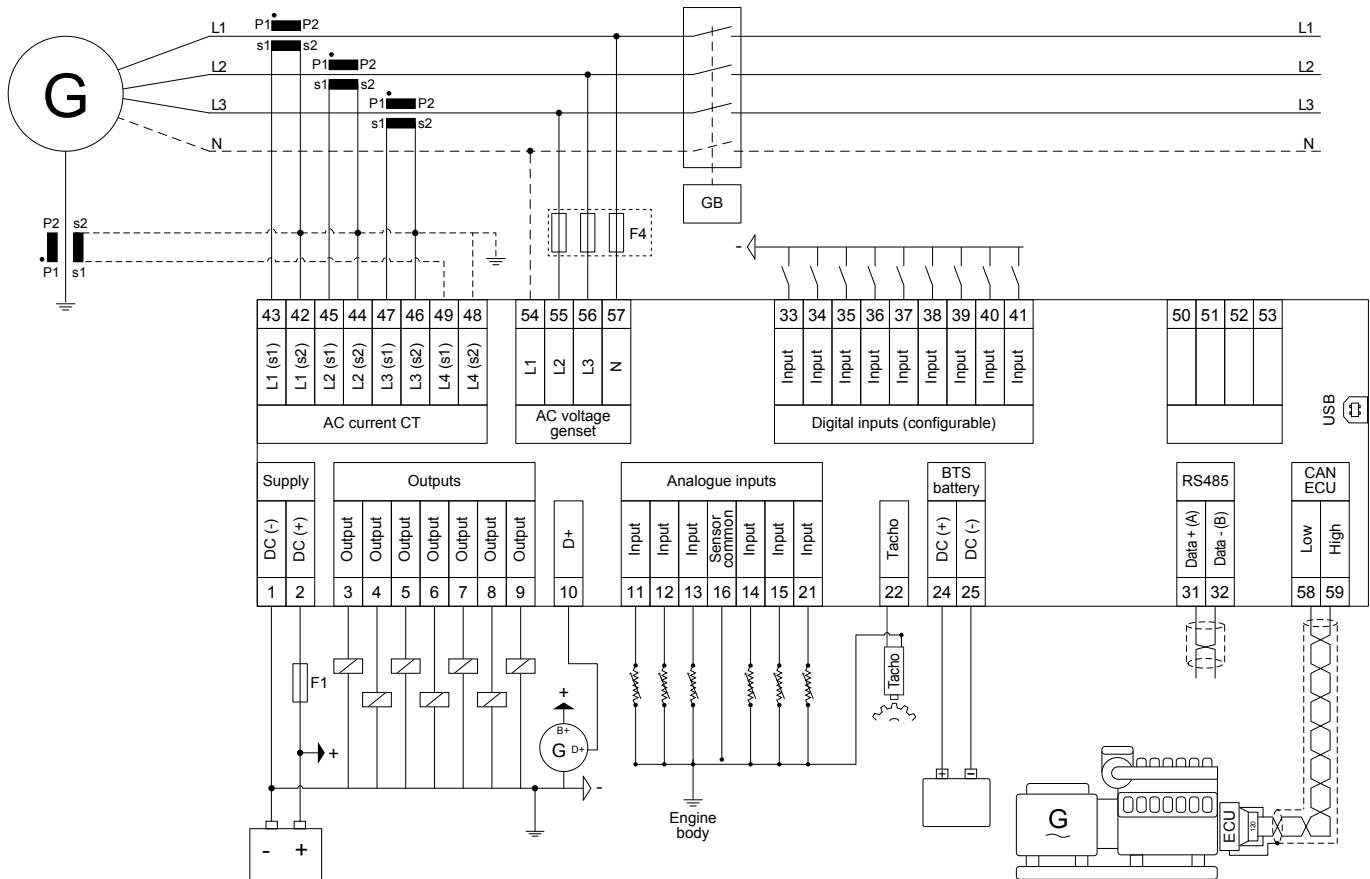



- NOTE**
- Wiring diagrams are examples. Use the application's wiring diagram during installation.
 - Genset and mains contactor latching relays should be compiled against 4 kV surge as per IEC-61000-4-5 standard.
 - Relay cards used with the controller should be protected against reverse battery voltages.
 - Analogue input 2 used for *Fuel level sensor* can be wired with the reference to *Battery Negative*, see **Specifications, Analogue resistive sensor inputs**.
 - Communication ports for CAN (terminals 58 and 59) and RS-485 (terminals 31 and 32) have built-in 120 Ω termination resistors.
 - If a digital output is connected to a relay, the relay must include freewheeling diodes.

5. Monitoring mode

5.1 Monitoring mode

In Monitoring mode, the display views shift automatically after a pre-defined time. This delay time can be configured in the configuration menu.

The views can also be changed manually with the Up  and Down  buttons.

Engine status and operating mode

	PRODUCT INFO
Prod ID: SGC410 - R.100	
Eng Sr: 000000000000	
Date: 10.July.2019 14:35	

Product info

	STATUS
Engine off - ready	
Manual Mode	

Manual mode

	STATUS
Engine off - ready	
Auto	

Auto mode

	STATUS
Engine off - ready	
Auto - BTS Bat Backup	

Auto - Site mode

	STATUS
Engine on - healthy	
DG ON rem min: 4	
Auto - Cyclic	

Auto - Cyclic mode

	AUTO EXERCISE-2
Freq:	Weekly
Next run:	Monday
	At 01:11Hrs
	For 00:23Hrs

Auto - Exercise mode

	GEN VOLTAGE
L1 245 V	L1-L2 424 V
L2 245 V 50.0 Hz	L2-L3 427 V
L3 247 V	L1-L3 427 V

Generator voltage

	GEN PWR FACTOR
1.00	PF - L1 1.00
PF	PF - L2 1.00
	PF - L3 1.00

Genset power factor

	LOAD APP. PWR
2.1	L1 0.7 kVA
kVA	L2 0.7 kVA
	L3 0.7 kVA

Load apparent power*

	LOAD POWER
2.1	L1 0.7 kVA
kVA	L2 0.7 kVA
	L3 0.7 kVA

Load power*

	LOAD CURRENT
L1	2.9 A
L2	2.9 A
L3	2.9 A



Load current*

	LOAD REACT. PWR
0.0	L1 0.0 kVAr
kVAr	L2 0.0 kVAr
	L3 0.0 kVAr



Load reactive power*

	GEN ENERGY
\$	1.9 kWh
	2.0 kVAh
	0.1 kVArh



Generator cumulative energy

	ENG LUB OIL PR
	10.0 bar
	145 psi



Engine lube oil pressure

	FUEL LEVEL
	41 %
	41 Litres



Engine fuel level

	ENG TEMP
	35 °C
	94 °F



Engine temperature

	SHELTER TEMP
	81 °C
	177 °F



Shelter temperature

	ENG SPEED
	1497 RPM

Engine speed

	ENG RUN TIME
	1 Hrs 29min STARTS 57 TRIPS 9

Engine run time

	BTS RUN TIME
	0 Hrs 1min



Site run time

	S2 Sensor
628.05	

Auxiliary sensor

	HISTOGRAM (%-hr)			
0-20	0:26	61-80	0:02	
21-40	0:00	81-100	0:32	
41-60	0:24	101+	0:00	

Histogram

	BATTERY
	ENG BATT 10.2 V BTS BATT 42.7 V

Engine/Site battery voltage

	ALARMS	1/1
Fail To Start		

Alarm (example)



6. Configuration mode

6.1 Configuration mode



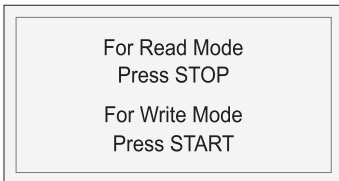

To configure the controller, follow these steps:

1. Press and hold the *Stop/Config*  button for at least three seconds.
2. The display shows

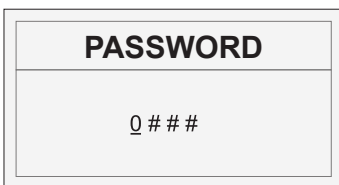

3. To see the configuration, press the *Stop/Config*  button. To change the configuration, press the *Start*  button.
4. The display shows



5. To enter the the four digit password:
 - Scroll through the digits with the *Up*  and *Down*  buttons.
 - Select a digit with the *Start*  button.
6. To leave the Configuration mode, press and hold the *Stop/Config*  button.
7. Until the configuration is saved, the display shows

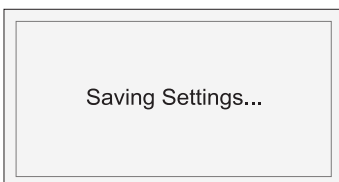

6.2 Configurable parameters

6.2.1 Configurable parameters

The tables give an overview of configurable parameters.

Level 1 (table titles) and Level 2 texts are shown twice:

- DEIF Smart Connect software: Normal sentence case, for example Power on Mode.
- Controller display: Capital case in brackets, for example (POWER ON MODE)

6.2.2 Module

Table 6.1 General (GENERAL)

Level 2	Range
Profile name	Profile 1
Power on Mode (POWER ON MODE)	Manual Auto
Power on Lamp Test (POWER ON LAMP TEST)	Enable Disable
Deep Sleep Mode (DEEP SLEEP MODE)	Enable Disable
Load Histogram (LOAD HISTOGRAM)	Enable Disable
Auto-Clear Warning Alarm (AUTO CLEAR WARNINGS)	Enable Disable
Language (LANGUAGE SUPPORT)	English Chinese

Table 6.2 Display (DISPLAY)

Level 2	Range
Contrast (CONTRAST)	0 to 100 %
Power Save Mode (POWER SAVE MODE)	Enable Disable

Table 6.3 Communication (RS485 COMM)

Level 2	Range
Communication Mode (COMM MODE)	None Modbus
Slave ID (MODBUS SLAVE ID)	1 to 247
Baudrate (BAUDRATE)	1200 2400 4800 9600 19200 38400 57600 115200
Parity Bit (PARITY)	None Even Odd

Table 6.4 Site Battery Monitoring (SITE BAT CONFIG)

Level 2	Range
Battery Monitoring	Enable

Level 2	Range
(BATTERY MON)	Disable
Low Voltage Threshold (LOW BATT THRESHOLD)	12.0 to 60.0 V
Battery Monitoring Delay (LOW BATT MON DELAY)	5 to 300 s
Genset Run Duration (GEN RUN DURATION)	1 to 720 min.

Table 6.5 Cyclic Mode (CYCLIC CONFIG)

Level 2	Range
Cyclic Mode (CYCLIC MODE)	Enable Disable
Genset Off Time (GEN OFF DURATION)	1 to 720 min.
Genset On Time (GEN ON DURATION)	1 to 720 min.

Table 6.6 Auto Exercise – Event 1 (AUTO EXERCISE – 1)

Level 2	Range
Auto Exercise (EVENT 1)	Enable Disable
Event Occurrence (EVENT OCCURENCE)	Daily Weekly Monthly
Event Day (EVENT DAY)	Daily: Runs every day Weekly: Sunday to Saturday Monthly: 1 to 28
Start Time (START TIME)	00:00 to 23:59 hour
Duration (GEN ON DURATION)	00 hr 01 min. to 99 hr 59 min.
Load Transfer (LOAD TRANSFER)	Enable Disable

Table 6.7 Auto Exercise – Event 2 (AUTO EXERCISE – 2)

Level 2	Range
Auto Exercise (EVENT 2)	Enable Disable
Event Occurrence (EVENT OCCURENCE)	Daily Weekly Monthly
Event Day (EVENT DAY)	Daily: Runs every day Weekly: Sunday to Saturday Monthly: 1 to 28
Start Time (START TIME)	00:00 to 23:59 hour

Level 2	Range
Duration (GEN ON DURATION)	00 hr 01 min. to 99 hr 59 min.
Load Transfer (LOAD TRANSFER)	Enable Disable

Table 6.8 Night Mode (NIGHT MODE)

Level 2	Range
Night Mode (NIGHT MODE RESTRICT)	Enable Disable
Night Mode Start Time (START TIME)	00:00 to 23:59 hour
Night Mode Off Duration (GEN OFF DURATION)	1 to 1440 min.

6.2.3 Digital inputs

Table 6.9 Digital Input # (DIG IN #)

Level 2	Range
Source (SOURCE)	See Digital input source selection in this document
Name (NAME)	Auxiliary Input #
Polarity (POLARITY)	Close to Activate Open to Activate
Action (ACTION)	None Notification Warning Electrical Trip Shutdown
Activation (ACTIVATION)	Never From Engine Start From Monitoring On Always
Activation Delay (ACTIVATION DELAY)	0 to 180 s

6.2.4 Analogue inputs

Table 6.10 Analogue Input 1 (LOP RES / DIG J)

Level 2	Range
Use Input As (SENSOR SELECTION)	Not used Digital Input J Lube Oil Pressure
(Digital) Source ((DIG) SOURCE)	See Digital input source selection in this document
Name (NAME)	Auxiliary Input J

Level 2	Range
(Digital) Polarity ((DIG) POLARITY)	Close to Activate Open to Activate
(Digital) Action ((DIG) ACTION)	None Notification Warning Electrical Trip Shutdown
(Digital) Activation ((DIG) ACTIVATION)	Never From Engine Start From Monitoring On Always
(Digital) Activation Delay ((DIG) ACTIVATION DELAY)	1 to 180 s
(LOP) Circuit Fault Action (OPEN CKT ALARM)	None Notification Warning Electrical Trip Shutdown
(LOP) Lube Oil Pressure Calibration Table	Resistance: 0 to 1000 Ω Pressure: 0.0 to 10.0 Bar

Table 6.11 Analogue Input 2 (FUEL LVL / DIG K)

Level 2	Range
Use Input As (SENSOR SELECTION)	Not used Digital Input K Fuel Level Sensor
(Digital) Source ((DIG) SOURCE)	See Digital input source selection in this document
Name (NAME)	Auxiliary Input K
(Digital) Polarity ((DIG) POLARITY)	Close to Activate Open to Activate
(Digital) Action ((DIG) ACTION)	None Notification Warning Electrical Trip Shutdown
(Digital) Activation ((DIG) ACTIVATION)	Never From Engine Start From Monitoring On Always
(Digital) Activation Delay ((DIG) ACTIVATION DELAY)	1 to 180 s
(FLS) Low Fuel Level Shutdown (SHUTDOWN)	Enable Disable
(FLS) Shutdown Threshold (SHUTDOWN THRESHOLD)	0 to 78 %
(FLS) Low Fuel Level Notification (NOTIFICATION)	Enable Disable

Level 2	Range
(FLS) Notification Threshold (NOTIFICATION THRESHOLD)	2 to 80 %
(FLS) Fuel Tank Capacity (FUEL TANK SIZE)	2 to 1000 litre
(FLS) Fuel Theft Warning (FUEL THEFT ALARM)	Enable Disable
(FLS) Fuel Theft Alarm Threshold (FUEL LVL THRESH)	1 to 100 % per hour
(FLS) Circuit Fault Action (OPEN CKT ALARM)	None Notification Warning Electrical Trip Shutdown
(FLS) Fuel Sensor Reference (FUEL LVL REF)	Battery Negative Engine Body
(FLS) Fuel Level Sensor Calibration Table	Resistance: 0 to 5000 Ω Fuel level: 0 to 100 %

Table 6.12 Analogue Input 3 (ENG TEMP / DIG L)

Level 2	Range
Use Input As (SENSOR SELECTION)	Not used Digital Input L Engine Coolant Temperature Sensor
(Digital) Source ((DIG) SOURCE)	See Digital input source selection in this document
Name (NAME)	Auxiliary Input L
(Digital) Polarity ((DIG) POLARITY)	Close to Activate Open to Activate
(Digital) Action ((DIG) ACTION)	None Notification Warning Electrical Trip Shutdown
(Digital) Activation ((DIG) ACTIVATION)	Never From Engine Start From Monitoring On Always
(Digital) Activation Delay ((DIG) ACTIVATION DELAY)	1 to 180 s
(ETS) Circuit Fault Action (OPEN CKT ALARM)	None Notification Warning Electrical Trip Shutdown
(ETS) Engine Temperature Sensor Calibration Table	Resistance: 0 to 5000 Ω Temperature: -25 to 300 °C

Table 6.13 S1 Sensor (AUX S1 RES / DIG M)

Level 2	Range
Use Input As (SENSOR SELECTION)	Not used Digital Input M S1 Sensor Shelter Temperature Sensor
(Digital) Source ((DIG) SOURCE)	See Digital input source selection in this document
Name (NAME)	Auxiliary Input M
(Digital) Polarity ((DIG) POLARITY)	Close to Activate Open to Activate
(Digital) Action ((DIG) ACTION)	None Notification Warning Electrical Trip Shutdown
(Digital) Activation ((DIG) ACTIVATION)	Never From Engine Start From Monitoring On Always
(Digital) Activation Delay ((DIG) ACTIVATION DELAY)	1 to 180 s
(S1) Shutdown (SHUTDOWN)	Enable Disable
(S1) Shutdown Threshold (SHUTDOWN THRESHOLD)	0.0 to 1000.0
(S1) Warning (WARNING)	Enable Disable
(S1) Warning Threshold (WARNING THRESHOLD)	0.0 to 1000.0
(S1) Threshold Type (THRESHOLD TYPE)	Greater Than Threshold Less Than Threshold
(S1) Circuit Fault Action (OPEN CKT ALARM)	None Notification Warning Electrical Trip Shutdown
(S1) Calibration Table	Resistance: 0 to 5000 Ω Value: 0 to 1000
(STS) High Temp Threshold (SHELT TEMP THRESH)	25 to 300 $^{\circ}\text{C}$
(STS) Shelter Temp Hysteresis (SHELT TEMP HYST)	1 to 100 $^{\circ}\text{C}$
(STS) Shelt Temp Monitoring Delay (SHELT TEMP DELAY)	5 to 300 s
(STS) Shelt Temp Run Duration (GEN RUN DURATION)	1 to 720 min.
(STS) Calibration Table (Resistive)	Resistance: 0 to 5000 Ω Temperature: -25 to 300 $^{\circ}\text{C}$

Table 6.14 S2 Sensor (AUX S2 RES / DIG N)

Level 2	Range
Use Input As (SENSOR SELECTION)	Not used Digital Input N S2 Sensor
(Digital) Source ((DIG) SOURCE)	See Digital input source selection in this document
Name (NAME)	Auxiliary Input N
(Digital) Polarity ((DIG) POLARITY)	Close to Activate Open to Activate
(Digital) Action ((DIG) ACTION)	None Notification Warning Electrical Trip Shutdown
(Digital) Activation ((DIG) ACTIVATION)	Never From Engine Start From Monitoring On Always
(Digital) Activation Delay ((DIG) ACTIVATION DELAY)	1 to 180 s
(S2) Shutdown (SHUTDOWN)	Enable Disable
(S2) Shutdown Threshold (SHUTDOWN THRESHOLD)	0.0 to 1000.0
(S2) Warning (WARNING)	Enable Disable
(S2) Warning Threshold (WARNING THRESHOLD)	0.0 to 1000.0
(S2) Threshold Type (THRESHOLD TYPE)	Greater Than Threshold Less Than Threshold
(S2) Circuit Fault Action (OPEN CKT ALARM)	None Notification Warning Electrical Trip Shutdown
(S2) Calibration Table	Resistance: 0 to 5000 Ω Value: 0 to 1000

Table 6.15 S3 Sensor (AUX S3 CURR / DIG O)

Level 2	Range
Use Input As (SENSOR SELECTION)	Not used Digital Input O 4 to 20 mA Sensor 0 to 5 V Sensor
(Digital) Source ((DIG) SOURCE)	See Digital input source selection in this document
Name	Auxiliary Input O

Level 2	Range
(NAME)	
(Digital) Polarity (DIG) POLARITY)	Close to Activate Open to Activate
(Digital) Action (DIG) ACTION)	None Notification Warning Electrical Trip Shutdown
(Digital) Activation (DIG) ACTIVATION)	Never From Engine Start From Monitoring On Always
(Digital) Activation Delay (DIG) ACTIVATION DELAY)	1 to 180 s
(4-20 mA) Shutdown (SHUTDOWN)	Enable Disable
(4-20 mA) Shutdown Threshold (SHUTDOWN THRESHOLD)	0.0 to 1000.0
(4-20 mA) Warning (WARNING)	Enable Disable
(4-20 mA) Warning Threshold (WARNING THRESHOLD)	0.0 to 1000.0
(4-20 mA) Threshold Type (THRESHOLD TYPE)	Greater Than Threshold Less Than Threshold
(4-20 mA) Circuit Fault Action (OPEN CKT ALARM)	None Notification Warning Electrical Trip Shutdown
(4-20 mA) Calibration Table (CURRENT)	Current: 4 to 20 mA Value: 0 to 1000
(0-5 V) Shutdown (SHUTDOWN)	Enable Disable
(0-5 V) Shutdown Threshold (SHUTDOWN THRESHOLD)	0.0 to 1000.0
(0-5 V) Warning (WARNING)	Enable Disable
(0-5 V) Warning Threshold (WARNING THRESHOLD)	0.0 to 1000.0
(0-5 V) Threshold Type (THRESHOLD TYPE)	Greater Than Threshold Less Than Threshold
(0-5 V) Circuit Fault Action (OPEN CKT ALARM)	None Notification Warning Electrical Trip Shutdown
(0-5 V) Calibration Table	Voltage: 0 to 5 V Value: 0 to 1000

Table 6.16 S4 Sensor (AUX S4 CURR / DIG P)

Level 2	Range
Use Input As (SENSOR SELECTION)	Not used Digital Input P 4 to 20 mA Sensor 0 to 5 V Sensor
(Digital) Source ((DIG) SOURCE)	See Digital input source selection in this document
Name (NAME)	Auxiliary Input P
(Digital) Polarity ((DIG) POLARITY)	Close to Activate Open to Activate
(Digital) Action ((DIG) ACTION)	None Notification Warning Electrical Trip Shutdown
(Digital) Activation ((DIG) ACTIVATION)	Never From Engine Start From Monitoring On Always
(Digital) Activation Delay ((DIG) ACTIVATION DELAY)	1 to 180 s
(4-20 mA) Shutdown (SHUTDOWN)	Enable Disable
(4-20 mA) Shutdown Threshold (SHUTDOWN THRESHOLD)	0.0 to 1000.0
(4-20 mA) Warning (WARNING)	Enable Disable
(4-20 mA) Warning Threshold (WARNING THRESHOLD)	0.0 to 1000.0
(4-20 mA) Threshold Type (THRESHOLD TYPE)	Greater Than Threshold Less Than Threshold
(4-20 mA) Circuit Fault Action (OPEN CKT ALARM)	None Notification Warning Electrical Trip Shutdown
(4-20 mA) Calibration Table (CURRENT)	Current: 4 to 20 mA Value: 0 to 1000
(0-5 V) Shutdown (SHUTDOWN)	Enable Disable
(0-5 V) Shutdown Threshold (SHUTDOWN THRESHOLD)	0.0 to 1000.0
(0-5 V) Warning Threshold (WARNING THRESHOLD)	0.0 to 1000.0
(0-5 V) Threshold Type (THRESHOLD TYPE)	Greater Than Threshold Less Than Threshold
(0-5 V) Circuit Fault Action (OPEN CKT ALARM)	None Notification

Level 2	Range
	Warning Electrical Trip Shutdown
(0-5 V) Calibration Table	Voltage: 0 to 5 V Value: 0 to 1000

6.2.5 Outputs

Table 6.17 Outputs # (OUT #)

Level 2	Range
Source (SOURCE)	See Digital output source selection in this document
On Activation (ON ACTIVATION)	Energise De-energise

6.2.6 Timers

Table 6.18 Cranking (CRANKING TIMERS)

Level 2	Range
Crank Hold Time (CRANK HOLD TIME)	1 to 15 s
Crank Rest Time (CRANK REST TIME)	2 to 60 s
Manual Start Delay (MANUAL START DELAY)	0 to 300 s
Auto Start Delay (AUTO START DELAY)	0 to 300 s

Table 6.19 Start/Stop (START/STOP TIMER)

Level 2	Range
Safety Monitoring Delay (SAFETY MONITOR DELAY)	10 to 60 s
Mains Detect Delay (MAINS DETECT DELAY)	1 to 300 s
Alternator Detect Delay (ALT DETECT DELAY)	1 to 30 s
Warm-Up Delay (WARM-UP DELAY)	0 to 60 s
Return To Mains Delay (RETN-TO-MAINS DELAY)	0 to 600 s
Engine Cooling Time (ENG COOL TIME)	0 to 300 s
Stop Action Time (STOP ACTION TIME)	10 to 120 s
Additional Stopping Time	0 to 120 s

Level 2	Range
(ADDN STOPPING TIME)	
Load Transfer Delay (LOAD TRANSFER DELAY)	1 to 60 s

Table 6.20 General (GENERAL TIMER)

Level 2	Range
Power Save Mode Delay (PWR SAVE MODE DELAY)	5 to 1800 s
Screen Changeover Time (SCRN CHNGOVER TIME)	1 to 1800 s
Deep Sleep Mode Delay (DEEP SLP MODE DELAY)	5 to 1800 s
Sounder Alarm Time (SOUNDER ALARM TIMER)	1 to 300 s
Test Mode Timer (TEST MODE TIMER)	1 to 720 min.
Auto Exit Config Mode (AUTO EXIT CNFG MODE)	10 to 1800 s

6.2.7 Generator

Table 6.21 Alternator configuration (ALT CONFIG)

Level 2	Range
Alternator Present (ALT PRESENT)	Yes No
Number of Poles (NUMBER OF POLES)	2/4/6/8
AC system (ALT AC SYSTEM)	1 phase 3 phase
Min Healthy Voltage (MIN HEALTHY VOLT)	50 to 350 V phase-neutral
Min Healthy Frequency (MIN HEALTHY FREQ)	10 to 75 Hz
Phase Reversal Detection (PHASE REVERSAL DETECT)	Enable Disable
Phase Reversal Action (PHASE REVERSAL ACTION)	None Notification Warning Electrical Trip Shutdown
Auto Load Transfer (AUTO LOAD TRANSFER)	Enable Disable
Alternator Wave Detection (ALT WAVE DETECT)	Enable Disable

Table 6.22 Voltage Monitoring (VOLT MONITOR)

Level 2	Range
Under-voltage Shutdown (UNDER VOLT SHUTDOWN)	Enable Disable
Under-voltage Shutdown Threshold (UV SHUTDOWN THRESH)	50 to 295 V phase-neutral
Under-voltage Warning (UNDER VOLT WARNING)	Enable Disable
Under-voltage Warning Threshold (UV WARNING THRESHOLD)	55 to 300 V phase-neutral
Over-voltage Shutdown (OVER VOLT SHUTDOWN)	Enable Disable
Over-voltage Shutdown Threshold (OV SHUTDOWN THRESH)	105 to 350 V phase-neutral
Over-voltage Warning (OVER VOLT WARNING)	Enable Disable
Over-voltage Warning Threshold (OV WARNING THRESHOLD)	100 to 345 V phase-neutral

Table 6.23 Frequency Monitoring (FREQ MONITOR)

Level 2	Range
Under-frequency Shutdown (UNDER FREQ SHUTDOWN)	Enable Disable
Under-frequency Shutdown Threshold (UF SHUTDOWN THRESH)	10.0 to 59.0 Hz
Under-frequency Warning Enable (UNDER FREQ WARNING)	Enable Disable
Under-frequency Warning Threshold (UF WARNING THRESHOLD)	11.0 to 60.0 Hz
Over-frequency Shutdown Enable (OVER FREQ SHUTDOWN)	Enable Disable
Over-frequency Shutdown Threshold (OF SHUTDOWN THRESH)	26.0 to 75.0 Hz
Over-frequency Warning Enable (OVER FREQ WARNING)	Enable Disable
Over-frequency Warning Threshold (OF WARNING THRESHOLD)	25.0 to 74.0 Hz

Table 6.24 Current Monitoring (CURRENT MONITOR)

Level 2	Range
CT Ratio (LOAD CT RATIO)	0 to 8000 / 5
Over-current Action (OVER CURR ACTION)	None Notification Warning Electrical Trip Shutdown

Level 2	Range
Over-current Threshold (OVER CURR THRESHOLD)	5 to 10000 A
Over-current Delay (OVER CURR DELAY)	1 to 600 s
CT Correction Factor	0.900 to 1.100
CT Location (CT LOCATION)	On Alt Output Cable On Load Cable

Table 6.25 Earth Leakage/Fan Current Monitoring (EARTH CURR MON)

Level 2	Range
Current Monitoring (FAN / EARTH MOMN)	Earth Leakage Current Fan Current
Current CT Ratio (CT RATIO)	0 to 8000 / 5
High Current Action (HIGH CURR ACTION)	None Notification Warning Electrical Trip Shutdown
High Current Threshold (HIGH CURR THRESH)	0.1 to 10.0 A
Current Delay (CURR DELAY)	5 to 60 s
Low Current Action (LOW CURR ACTION)	None Notification Warning Electrical Trip Shutdown
Low Current Threshold (LOW CURR THRESH)	0.1 to 9.9 A

Table 6.26 Load Monitoring (LOAD MONITOR)

Level 2	Range
Generator Rating (GEN RATING)	0 to 8000 kW
Overload Action (OVERLOAD ACTION)	None Notification Warning Electrical Trip Shutdown
Overload Threshold (OVERLOAD THRESHOLD)	50 to 150 %
Overload Monitoring Delay (OVERLOAD MON DELAY)	1 to 600 s
Unbalanced Load Action (UNBAL LOAD ACTION)	None Warning Electrical Trip Shutdown

Level 2	Range
	Notification
Unbalanced Load Threshold (UNBAL LOAD THRESHOLD)	5 to 200 %
Unbalanced Load Delay (UNBAL LOAD DELAY)	1 to 600 s

6.2.8 Mains

Table 6.27 Configuration (MAINS CONFIG)

Level 2	Range
Mains Monitoring (MAINS MONITORING)	Enable Disable
Mains AC System (MAINS AC SYSTEM)	1 phase 3 phase
Phase Reversal Detection (PHASE REVERSAL DETECT)	Enable Disable
Phase Reversal Action (PHASE REVERSAL ACTION)	None Notification
Partial Healthy Detection (MAINS PARTIAL HEALTHY)	Enable Disable

Table 6.28 Voltage Monitoring (VOLT MONITOR)

Level 2	Range
Under-voltage (UV ENABLE)	Enable Disable
(UV) Trip (UV TRIP)	50 to 298 V phase-neutral
(UV) Return (UV RETURN)	52 to 300 V phase-neutral
Over-voltage (OV ENABLE)	Enable Disable
(OV) Return (OV RETURN)	100 to 348 V phase-neutral
(OV) Trip (OV TRIP)	102 to 350 V phase-neutral

Table 6.29 Frequency Monitoring (FREQ MONITOR)

Level 2	Range
Under-frequency (UF ENABLE)	Enable Disable
(UF) Trip (UF TRIP)	10.0 to 59.0 Hz
(UF) Return (UF RETURN)	11.0 to 60.0 Hz
Over-frequency	Enable

Level 2	Range
(OF ENABLE)	Disable
(OF) Return (OF RETURN)	25.0 to 74.0 Hz
(OF) Trip (OF TRIP)	26.0 to 75.0 Hz

6.2.9 Engine

Table 6.30 Crank Disconnect (CRANK DISCONN)

Level 2	Range
Start Attempts (START ATTEMPTS)	1 to 9
Disconnect on Oil Pressure Sensor (DISCONN ON LOP SENS)	Enable Disable
Monitor Pressure Sensor Before Crank (MON LLOP BEF CRANK)	Enable Disable
Pressure Sensor Monitoring Threshold (DISCONN LOP SENS)	0.5 to 10.0 bar
Monitor Pressure Switch Before Crank (MON LOP BEF CRANK)	Enable Disable
Disconnect on Oil Pressure Switch (DISCONN ON LLOP SW)	Enable Disable
Pressure Switch Transient Time (LLOP SW TRANS TIME)	0.0 to 3.0 s
Crank Disconnect At Alt Frequency (ALT FREQUENCY)	10 to 70 Hz
Crank Disconnect At Engine Speed (ENGINE SPEED)	150 to 4000 RPM
Disconnect On Charging Alt Voltage (DISC ON CHG ALT VOLT)	Enable Disable
Charging Alt Disconnect Volt Threshold (CHG ALT THRESHOLD)	5.0 to 30.0 V

Table 6.31 Speed Monitoring (SPEED MONITOR)

Level 2	Range
Engine Speed Sense Source (SPEED SENSE SOURCE)	Alternator frequency Magnetic Pickup W-Point Frequency
Flywheel Teeth (Magnetic Pickup)	1 to 300
W-Point Frequency@ 1500	0 to 500
Under-speed Shutdown (UNDER SPEED SHUTDOWN)	Enable Disable
Under-speed Threshold (UNDER SPEED THRESH)	0 to 3600 RPM
Under-speed Delay (UNDER SPEED DELAY)	1 to 60 s

Level 2	Range
Over-speed Threshold (OVER SPEED THRESH)	700 to 4000 RPM
Over-speed Delay (OVER SPEED DELAY)	1 to 20 s
Gross Over-speed Threshold (GROSS OS THRESHOLD)	100 to 200 %

Table 6.32 Battery Monitoring (BATTERY MONITOR)

Level 2	Range
Low Battery Voltage Action (LOW VOLT ACTION)	None Notification Warning Electrical Trip Shutdown
Low Battery Voltage Threshold (LOW VOLT THRESHOLD)	8.0 to 31.0 V
Low Battery Voltage Delay (LOW VOLT DELAY)	5 to 1800 s
High Battery Voltage Action (HIGH VOLT ACTION)	None Notification Warning Electrical Trip Shutdown
High Battery Voltage Threshold (HIGH VOLT THRESHOLD)	9.0 to 32.0 V
High Battery Voltage Delay (HIGH VOLT DELAY)	5 to 1800 s

Table 6.33 Charging Alternator Monitoring (CHARGE ALT MON)

Level 2	Range
Charging Alternator Fail Action (FAIL ACTION)	None Notification Warning Electrical Trip Shutdown
Charging Alternator Fail Threshold (FAIL THRESHOLD)	0.0 to 35.0 V
Charging Alternator Fail Delay (FAIL DELAY)	5 to 60 s

Table 6.34 Preheating (PREHEAT)

Level 2	Range
Pre-heat Timer (PREHEAT TIMER)	1 to 900 s
Engine Temperature (ENG TEMP EN)	Enable Disable
Engine Temperature Threshold	10 to 300 °C

Level 2	Range
(ENG TEMP LIMIT)	

Table 6.35 Engine Control Unit (ECU)

Level 2	Range
Engine Type	None Generic J1939 Scania Volvo Iveco Deutz - MVR MTU Cummins
Measurements from the ECU	
Lube Oil Pressure	Enable Disable
Coolant Temperature	Enable Disable
Engine Speed	Enable Disable
Running Hours	Enable Disable
Battery Voltage	Enable Disable
Controls To ECU	
Speed	Enable Disable
Engine Requested Speed	500 to 4000
Start/Stop	Enable Disable
Preheat	Enable Disable
ECU Communication Failure	
Action	None Notification Warning Electrical Trip Shutdown
Activation	Never From Engine Start From Monitoring On Always While Fuel Relay ON
Activation Delay	1 to 60 s
Communication Setup	
SGC Source Address	0 to 253
ECU Source Address	0 to 253
ECU Diagnostic Lamps (Amber, Red, Malfunction, Protect)	

Level 2	Range
Action	None Notification Warning Electrical Trip Shutdown
Activation	Never From Engine Start From Monitoring On Always
Activation Delay	0 to 60 s

Table 6.36 Lube Oil Pressure (LOP)

Level 2	Range
Low Level Shutdown	Enable Disable
Shutdown Threshold	0.0 to 9.8 Bar
Low Level Warning	Enable Disable
Warning Threshold	0.2 to 10.0 Bar

Table 6.37 Engine Coolant Temperature (ENG COOL TEMP)

Level 2	Range
High Level Shutdown	Enable Disable
Shutdown Threshold	27 to 300 °C
High Level Warning	Enable Disable
Warning Threshold	25 to 298 °C

6.2.10 Maintenance

Table 6.38 Maintenance (MAINT ALARM)

Level 2	Range
Alarm Action (ACTION)	Notification Warning
Due At Engine Hours (DUE AT ENGINE HOURS)	10 to 65000 hours
Alarm Due Date (ALARM DUE DATE)	dd/mm/yyyy

6.2.11 Password ID

Table 6.39 ID

Level 1	Level 2	Range
(ENG SR NO)	#####	Numbers: 0 to 9

Level 1	Level 2	Range
		Letters: A to Z
(PASSWORD 1)	####	Numbers: 0 to 9
(PASSWORD 2)	####	Numbers: 0 to 9

6.3 Digital input source selection

No.	Input source (on the display)
1	Not used
2	User Configured
3	Low Fuel LVL Switch
4	Low Lube Oil Press Switch
5	High Engine Coolant Temp Switch
6	Low Water LVL Switch
7	Emergency Stop
8	Remote Start/Stop
9	Simulate Start
10	Simulate Stop
11	Simulate Auto
12	Close Gen/Open Mains Swch
13	Close Mains/Open Gen Swch
14	Simulate Mains
15	V-Belt Broken Switch
16	Mains Contactor Latched
17	Genset Contactor Latched
18	Battery Charger Fail
19	Smoke Fire
20	Remote Alarm Mute
21	Remote Alarm Acknowledge
22	Stop and Panel Lock
23	External Panel Lock
24	Generator Load Inhibit
25	Mains Load Inhibit

6.4 Digital output source selection

No.	Output source (on the display)
1	Disable
2	Sounder Alarm
3	Battery Over Volt
4	Battery Under Volt
5	Charge Alt Shutdown

No.	Output source (on the display)
6	Charge Alt Warning
7	Close Gen Contactor
8	Close Mains Contactor
9	Mains Failure
10	Common Alarm
11	Common Electrical Trip
12	Common Shutdown
13	Common Warning
14	Cooling Down
15	Dig In A
16	Dig In B
17	Dig In C
18	Dig In D
19	Dig In E
20	Dig In F
21	Dig In G
22	Dig In H
23	Dig In I
24	Dig In J (LOP Resistive)
25	Dig In K (Anlg In Fuel LVL)
26	Dig In L (Anlg In Eng Temp)
27	Dig In M (Aux Sensor 1)
28	Dig In N (Aux Sensor 2)
29	Dig In O (Aux Sensor 3)
30	Dig In P (Aux Sensor 4)
31	Emergency Stop
32	Stop Solenoid
33	Fail To Start
34	Fail To Stop
35	Fuel Relay
36	Gen Available
37	L1 Phase OV Shutdown
38	L1 Phase UV Shutdown
39	L2 Phase OV Shutdown
40	L2 Phase UV Shutdown
41	L3 Phase OV Shutdown
42	L3 Phase UV Shutdown
43	Gen Over Current
44	High Engine Coolant Temp

No.	Output source (on the display)
45	Low Fuel LVL
46	Low LOP
47	Mains High Volt
48	Mains Low Volt
49	(Res) Pressure Open Circuit
50	Open Gen Contactor
51	Open Mains Contactor
52	Over Freq Shutdown
53	Over Speed Shutdown
54	Gross Over Speed Shutdown
55	Start Relay
56	Temp Sensor Open Circuit
57	Under Freq Shutdown
58	Under Speed Shutdown
59	Maintenance Due
60	Stop Mode
61	Auto Mode
62	Manual Mode
63	Preheat Output
64	Calling For Scheduler Run
65	Stop and Panel Lock
66	External Auto Panel Lock
67	Fail To Close Generator
68	Fail To Close Mains
69	Loading Volt Not Reached
70	Loading Freq Not Reached
71	MPU Loss
72	BTS Battery hybrid mode

7. Running modes

7.1 Auto mode

Select Auto mode with the *Mode selection*  button.

Exercise Mode

Two scheduled sequences to start and stop the genset can be configured with SGC 410.

Exercise mode occurs when the controller is in Auto mode with no shutdown or warning alarms. In this mode, load transfer on mains/genset is configurable. Scheduled sequences can be configured to repeat daily, weekly or monthly.





- If the controller is in Auto mode, Exercise mode runs at the scheduled time for preset DG ON duration time. The controller exits Exercise mode if the DG ON duration time expires or if the *Stop/Config*  button is pressed during a scheduled sequence.
- If the controller is in Manual mode when the scheduled sequence begins, the genset will not start. If the controller is switched to Auto mode during the Exercise, the genset will start and run for the remaining scheduled time.
- The genset controller will not respond to a Remote start command in Exercise mode.
- If both exercises are scheduled at the same time, the Start time for second exercise is increased by one minute.

Deep sleep mode

Deep sleep mode is a useful feature to extend the battery lifetime. This is done by suspending normal functions of the controller, and place it in the lowest power consumption state. The controller maintains the status and alarms it had before Deep sleep mode. When the controller wakes up, normal operations are resumed automatically.

The controller goes to Deep sleep mode when there is no user interaction for the preset Deep sleep mode delay time. The controller does not go to Deep sleep mode when in Auto mode (Exercise) or when Modbus communication is enabled.

To wake the controller from Deep sleep mode, press:

- *Stop/Config*  button
- *Start*  button
- *Mode selection*  button
- *Acknowledge*  button

7.2 Manual mode

Module Operation in Manual Mode

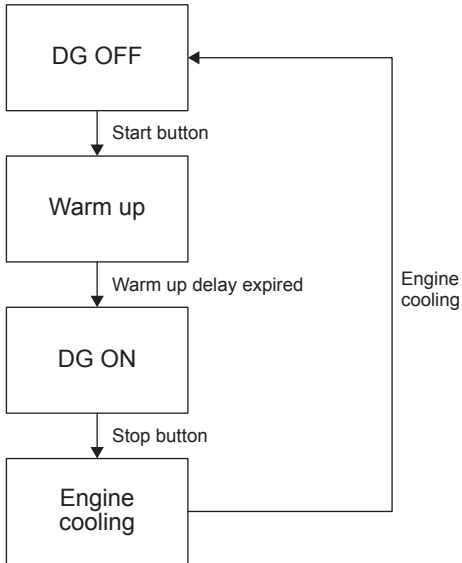

Start the engine

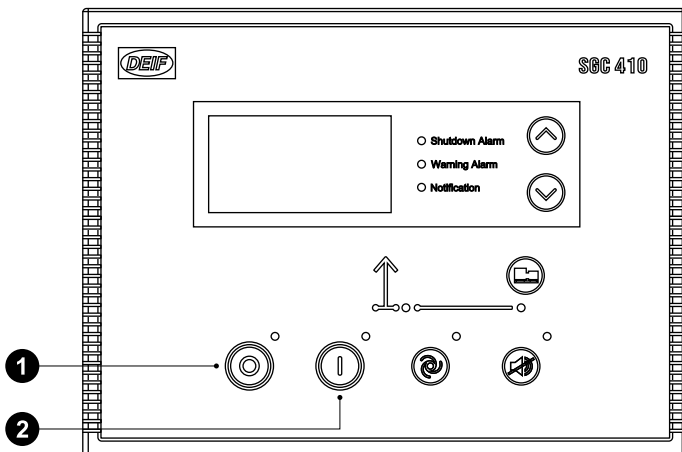

- Press the *Stop/Config* button.
- Press the *Start* button to crank the engine

If the *Start* button is pressed in this mode, the controller sends a Start command and the genset starts according to the Start sequence. When the genset loading voltage and frequency are above the Minimum healthy thresholds, the Warm-up delay timer starts. At the end of the Warm-up delay, the Load transfer delay starts and the genset latches. The running hours stop increasing when a Stop command is received.

Stop the engine

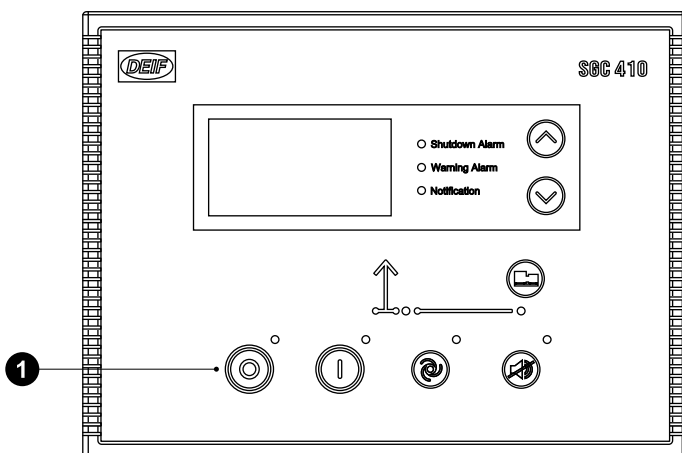



- Press the *Stop/Config* button to stop the running engine.
- Press the *Stop/Config* button twice to stop the engine immediately.

When the *Stop/Config* button is pressed, the controller opens the genset contactor, and the Engine cooling time starts. At the end of the Engine cooling time, the controller initiates the Stop sequence by giving the Stop command.

If the *Stop/Config* button is pressed during Engine cooling time, the controller skips the Cooling time and sends the Stop command immediately.

Test mode

In manual mode (while the genset is OFF) if the *Mode selection*  button is long pressed, the controller goes in Test mode. Test mode is almost the same as manual mode, but in Test mode the genset contactor will not get latched. If the *Genset contactor latching*  button is pressed, only the genset contactor gets latched. Once the genset starts in Test mode, the Test mode timer starts. After the *Stop/Config*  button is pressed or the timer has run out, the controller sends a Stop command and the genset stops according to the Stop sequence.

Acknowledge and clear alarms

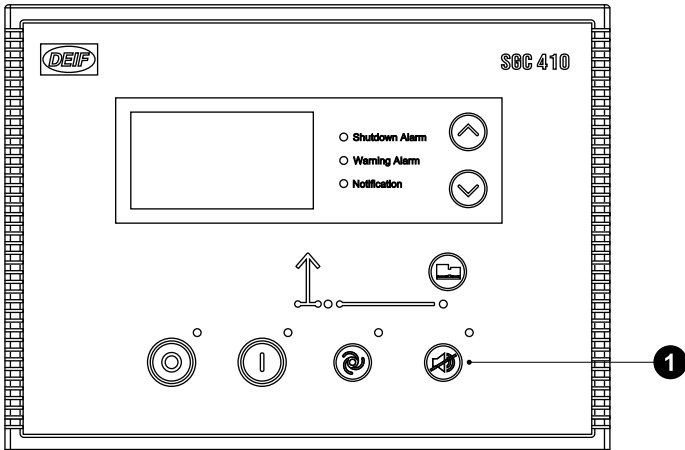

- Press the *Acknowledge*  button to acknowledge the alarm in any mode.

NOTE If Engine ON is detected without any start command is given to the controller, the engine will remain ON. Other actions will be according to operating mode and configuration.

7.3 Start and stop sequences

Start sequence

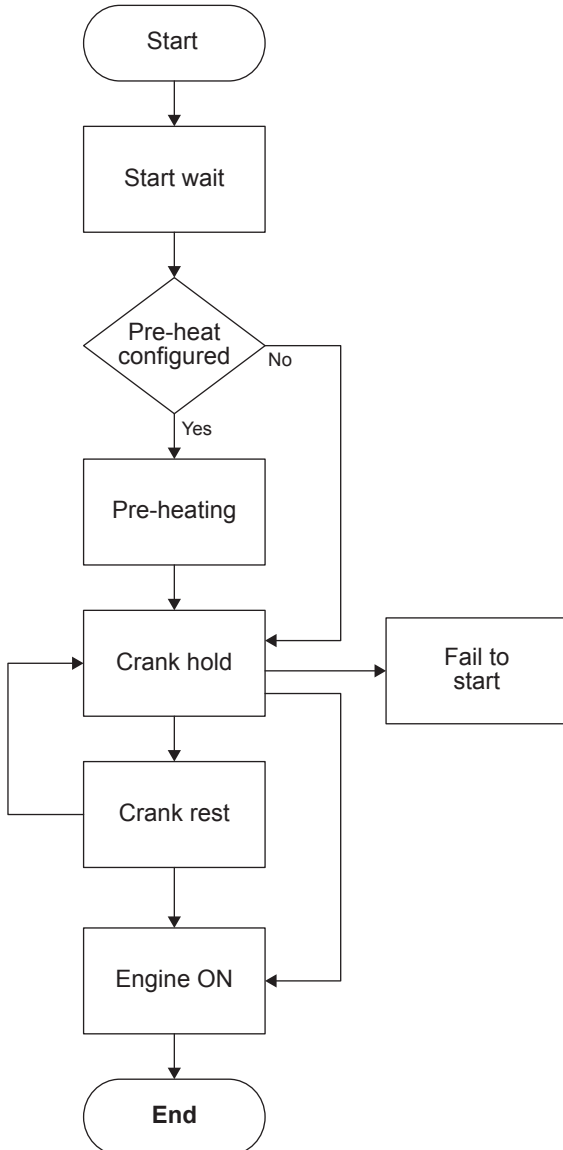

When the controller receives the Start command, it goes to the Start wait state.

After the Start delay (Manual or Auto start delay) has expired, the controller will:

- If Pre-heating is not configured, the controller goes to Crank hold state and activate the Start relay output.
- If Pre-heating is configured, the controller goes to the Pre-heating state. When the Pre-heating time is over or the Pre-heating temperature threshold is reached, the controller goes to the Crank hold state.

If the Crank is not disconnected and the Crank hold time has expired, the controller goes to the Crank rest state.

If the Crank is not disconnected and Crank rest time has expired, the controller goes to the Crank hold state for the next cranking attempt.

If the Crank is disconnected in the Crank hold or Crank rest states, the controller goes to the Engine ON state.

If the maximum cranking attempts are done, the controller shows the Fail to start alarm.

Stop sequence

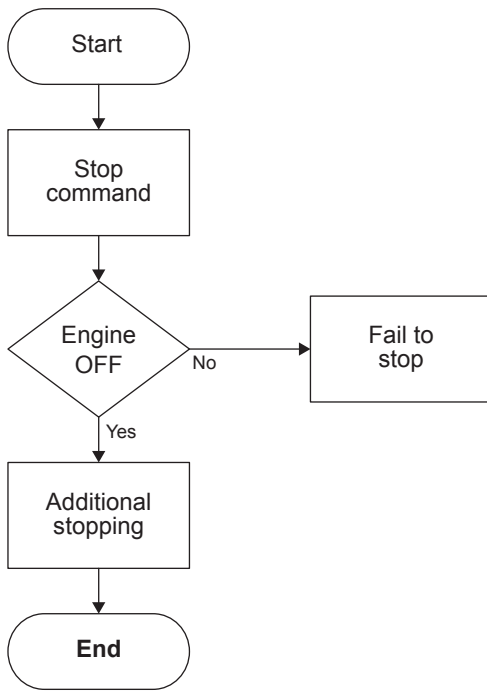

When the controller receives the Stop command, it goes to the Stop state, starts the Stop action time and activates the Stop solenoid output.

If Engine OFF is detected before the Stop action time is over, the controller overrides the Stop action time.

When the Additional stopping time is over, the controller goes to the Engine OFF state and deactivates the Stop solenoid output.

If Engine OFF is not detected before the Stop action time, the controller shows the Fail to stop alarm.

8. Load detection

8.1 Load detection in Auto mode

The controller detects the load (on mains/genset) from the contactor outputs, for example Close genset contactor and Close mains contactor or Open mains contactor and Open genset contactor. These outputs must be configured in accordance with different types of Auto operating modes and configuration.

Contactor status inputs are not used for load sensing in any type of Auto mode.

For Mains load sensing, two configurations are mandatory:

1. Mains monitoring must be enabled.
2. The CT location in the panel and the controller configuration must be on the load cable.

8.2 Load detection in Manual mode

The controller uses one of the following methods to detect loads during Manual mode:

- The controller detects the load (on mains/genset) depending on the Generator contactor latched and the Mains contactor latched inputs (if configured) and their real-time status.
- If the inputs are not configured, the controller detects the load depending on the Close genset contactor and Close mains contactor or Open mains contactor and Open genset contactor outputs. These outputs are configured with the controller buttons or contactor controlling inputs, for example Close genset/Open mains or Close mains/Open genset.

In case of MCP Panels, since the genset and mains contactors are not configured, the detected load is treated as load on the genset only.

9. Features

9.1 About Features

The controller includes features to save power and monitor the genset load.

9.2 Auto config exit mode

In this mode, the controller automatically exits the Configuration mode when there is no user interaction for the preset Auto config exit mode delay time.

The controller saves all the configuration parameter changes and exits Configuration mode.

9.3 Load histogram

Load histogram displays the engine running hours in load groups. This mode helps the user to monitor the time of a genset runs with a specific percentage of load.

The load percentage is calculated based on following parameters:

- Generator rating
- CT ratio

10. Alarms

10.1 Alarms

When a Shutdown alarm occurs the controller commands the genset to stop. The controller does not send the start command if the Shutdown alarm is not acknowledged.

When an Electrical trip alarm occurs, the controller opens the genset contactor and then commands the genset to stop. The controller does not send the start command if the Electrical trip alarm is not acknowledged.

If the Warning alarm occurs while the genset runs, the controller does not send the stop command. But if the Warning alarm is not acknowledged when the genset is stopped, the genset cannot be started.

If Auto warning clear is enabled, the Warning alarms are automatically cleared when the conditions that triggered the alarm are cleared.

Alarm types

No.	Alarm actions	Description
1	Shutdown	Load is taken off from the genset and the genset is immediately stopped by skipping the Engine cooling time.
2	Electrical trip	Load is taken off from the genset, the Engine cooling timer begins, after which the genset is stopped.
3	Warning	Warning alarms draw the operator's attention to an undesirable condition without affecting the genset's operation. The genset cannot be started without acknowledging the Warning alarms
4	Notification	The controller shows the message on the display. The genset start/stop operation is not affected.

Alarms and their causes

No.	Alarms	Causes/Indication	Actions
1	Low Oil Pressure (Sensor)	Indicates that the oil pressure measured is below the preset threshold.	None Shutdown Warning
	Low Oil Pressure (Switch)	Indicates that the oil pressure measured is low through switch.	None Shutdown Warning Electrical Trip Notification
2	LOP Res Sensor - Ckt Open	The oil pressure sensor is not detected (circuit open).	None Shutdown Warning Electrical Trip Notification
3	High Eng Temp (sensor)	Indicates that the engine temperature is above the preset threshold. This condition is detected only when engine is on.	None Shutdown Warning
	High Eng Temp (Switch)	Indicates that the engine temperature measured is high through switch.	None Shutdown Warning Electrical Trip Notification
4	Eng Temp - Ckt Opn	The temperature sensor is not detected (circuit open).	None

No.	Alarms	Causes/Indication	Actions
			Shutdown Warning Electrical Trip Notification
5	Low Fuel level (Sensor)	Indicates that the amount of fuel level is below the preset threshold. This condition is detected only when engine is on.	None Shutdown Warning
	Low Fuel level (Switch)	Indicates that the amount of fuel level measured is low through switch.	None Shutdown Warning Electrical Trip Notification
	Fuel level - Ckt Open	The fuel level sensor is not detected (circuit open).	None Shutdown Warning Electrical Trip Notification
6	Fuel Theft	The fuel consumption has exceeded the preset threshold.	Warning
7	Low Water Level Switch	Indicates that radiator water level is below the preset threshold.	None Shutdown Warning Electrical Trip Notification
8	Shelter Temp - Ckt Open	Shelter temperature sensor is not detected (circuit open).	Notification
9	Aux S2 - Ckt Open	Auxiliary sensor S2 is not detected (circuit open).	None Shutdown Warning Electrical Trip Notification
10	Auxiliary Input (for example, Aux_A - P)/user defined name	Configured auxiliary input has triggered longer than the preset duration.	None Shutdown Warning Electrical Trip Notification
11	Emergency Stop	When emergency stop switch is pressed and immediate shutdown is required.	Shutdown
12	Fail To Stop	It is detected that genset is still running after sending stop command.	Shutdown
13	Fail To Start	Indicates that genset has not started after the preset number of start attempts.	Shutdown
14	L1 Phase Over Voltage	Indicates that genset (L1) phase voltage has exceeded the preset over-voltage threshold.	Shutdown Warning
15	L2 Phase Over Voltage	Indicates that genset (L2) phase voltage has exceeded the preset over-voltage threshold.	Shutdown Warning
16	L3 Phase Over Voltage	Indicates that genset (L3) phase voltage has exceeded the preset over-voltage threshold.	Shutdown Warning
17	L1 Phase Under Voltage	Indicates that genset (L1) phase voltage has fallen below the preset under-voltage threshold.	Shutdown Warning
18	L2 Phase Under Voltage	Indicates that genset (L2) phase voltage has fallen below the preset under-voltage threshold.	Shutdown Warning

No.	Alarms	Causes/Indication	Actions
19	L3 Phase Under Voltage	Indicates that genset (L3) phase voltage has fallen below the preset under-voltage threshold.	Shutdown Warning
20	DG Phase Reversed	Alternator phase sequence (L1-L2-L3) is not correct.	None Shutdown Warning Electrical Trip Notification
21	Mains Phase Reversed	Mains is in unhealthy condition.	None Notification
22	Over Frequency	Indicates that genset output frequency has exceeded the preset threshold.	Shutdown Warning
23	Under Frequency	Indicates that genset output frequency has fallen below the preset threshold.	Shutdown Warning
24	Over Current	Indicates that genset current has exceeded the preset threshold.	None Shutdown Warning Electrical Trip Notification
25	Over Load	Indicates that the measured kW load rating has exceeded the preset threshold.	None Shutdown Warning Electrical Trip Notification
26	Unbalanced Load	Load on any phase is greater or less than other phases by a threshold value.	None Shutdown Warning Electrical Trip Notification
27	Over Speed	Indicates that genset speed has exceeded the preset overspeed threshold. Genset will shut down after Overspeed delay.	Shutdown
28	Gross Over Speed	Indicates that genset speed has exceeded the preset Gross overspeed threshold. Genset will shut down immediately without any delay.	Shutdown
29	Under Speed	The engine speed has fallen below the preset RPM.	Shutdown
30	Charge Fail	The charge alternator voltage has dropped below the preset threshold.	None Shutdown Warning Electrical Trip Notification
31	Battery Under Voltage	The battery voltage has fallen below the preset threshold.	None Shutdown Warning Electrical Trip Notification
32	Battery Over Voltage	The battery voltage has exceeded the preset threshold.	None Shutdown Warning Electrical Trip Notification
33	High Oil Press Detected	Lube oil pressure is detected above the crank disconnect threshold when the engine is off.	Warning

No.	Alarms	Causes/Indication	Actions
34	Maintenance Due	Indicates that engine running hours has exceeded the preset hours limit or maintenance due date has occurred and filter servicing is required.	Warning Notification
35	Battery Charger Fail	Indicates the battery is not getting charged by the charger.	None Shutdown Warning Electrical Trip Notification
36	Smoke Fire	Controller has detected smoke / fire through its digital input.	None Shutdown Warning Electrical Trip Notification
37	Aux S2/user defined name	Auxiliary sensor S2's threshold being crossed.	None Shutdown Warning Electrical Trip Notification

11. Modbus communication protocol

11.1 About the Modbus communication protocol

SGC 420 supports a custom protocol based on the standard Modbus over an RS-485 layer. operates in a slave mode and responds to commands received from an external Modbus master.

11.2 Modbus connection details

The transmission mode used by SGC 420/421 is Modbus RTU (not Modbus ASCII). The byte format for communication is 1 start bit, 8 data bits, no parity bits and 1 stop bit, Cyclic Redundancy Check (CRC).

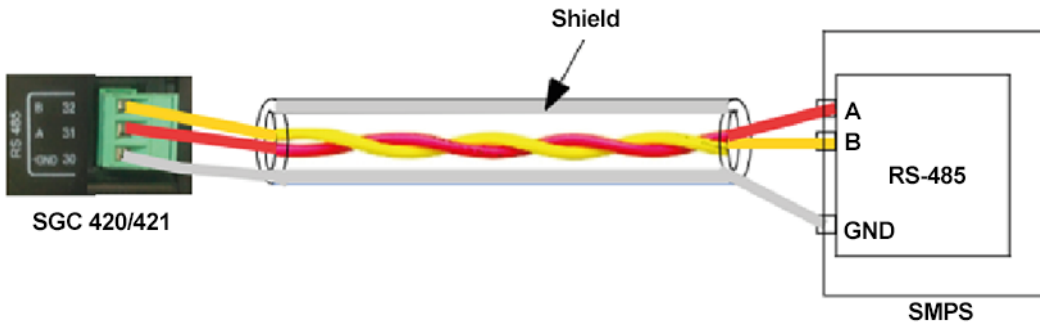

Precautions

- Find the slave ID from the SMPS and configure the same ID in the controller.
- Enable the controller in the configuration of the SMPS after hardware connections are made.
- Connect the controller terminals 31 and 32 to the SMPS terminals A and B.
- Connect the controller terminal 30 to the ground of the SMPS. If the SMPS ground is not present, leave the controller terminal 30 open.
- Use a two-core shielded cable for connection.
- Use different colour wires for terminals 31 and 32 for easy detection and connection.
- Route the wires properly ensuring they do not get short with any other wires.
- Do not use multi strand wires for the connection.

11.3 Modbus functions

This genset controller operates as a Modbus slave that responds to certain commands (or functions, as defined by Modbus standard) received from the Modbus master in appropriate format. Supported functions and respective command-response structure is as shown below. If the command received from the Modbus master is other than the three functions mentioned below, an exception message is generated.

Function code	Modbus name	Description
03	Read holding register	Reads one or more 16-bit registers from the slave device read/write location.
16	Write holding register	Writes one or more 16-bit registers to the slave device.

12. Modbus communication settings

12.1 Modbus communication settings

RS-485 communication settings

- Slave ID: 1 to 247
- Baud rate: 1200/2400/4800/9600/19200/38400/57600/115200 bps
- Parity: None/Even/Odd
- Stop bit: 1, 2
- Recommended polling frequency: 50 Hz
- No response timeout: 250 ms

12.2 Register map (function code 03)

Register address	Parameter	Scale factor	Unit/ Interpretation	Bits/Sign
0	Protocol revision	-	-	Unsigned
1	Generator L1-N voltage	0.1	V	Unsigned
2	Generator L2-N voltage	0.1	V	Unsigned
3	Generator L3-N voltage	0.1	V	Unsigned
4	Generator L1-L2 voltage	0.1	V	Unsigned
5	Generator L2-L3 voltage	0.1	V	Unsigned
6	Generator L3-L1 voltage	0.1	V	Unsigned
7	Generator L1 frequency	0.1	Hz	Unsigned
8	Generator L2 frequency	0.1	Hz	Unsigned
9	Generator L3 frequency	0.1	Hz	Unsigned
10	Generator power factor L1	0.01	--	Unsigned
11	Generator power factor L2	0.01	--	Unsigned
12	Generator power factor L3	0.01	--	Unsigned
13	Generator average power factor	0.01	--	Unsigned
14	Mains L1-N voltage	0.1	V	Unsigned
15	Mains L2-N voltage	0.1	V	Unsigned
16	Mains L3-N voltage	0.1	V	Unsigned
17	Mains L1-L2 voltage	0.1	V	Unsigned
18	Mains L2-L3 voltage	0.1	V	Unsigned
19	Mains L3-L1 voltage	0.1	V	Unsigned
20	Mains L1 frequency	0.1	Hz	Unsigned
21	Mains L2 frequency	0.1	Hz	Unsigned
22	Mains L3 frequency	0.1	Hz	Unsigned
23	Load L1 current	0.1	A	Unsigned
24	Load L2 current	0.1	A	Unsigned
25	Load L3 current	0.1	A	Unsigned
26	Load L1 watts	0.1	kW	Unsigned

Register address	Parameter	Scale factor	Unit/ Interpretation	Bits/Sign
27	Load L2 watts	0.1	kW	Unsigned
28	Load L3 watts	0.1	kW	Unsigned
29	Load total watts	0.1	kW	Unsigned
30	Percentage Load	1	kW	Unsigned
31	Load L1 VA	0.1	kVA	Unsigned
32	Load L2 VA	0.1	kVA	Unsigned
33	Load L3 VA	0.1	kVA	Unsigned
34	Load total VA	0.1	kVA	Unsigned
35	Load L1 var	0.1	kvar	Unsigned
36	Load L2 var	0.1	kvar	Unsigned
37	Load L3 var	0.1	kvar	Unsigned
38	Load total var	0.1	kvar	Unsigned
39-40	Generator cumulative energy	0.1	kWh	Unsigned
41-42	Generator cumulative apparent energy	0.1	kVAh	Unsigned
43-44	Generator cumulative reactive energy	0.1	kvarh	Unsigned
45-46	Mains cumulative energy	0.1	kWh	Unsigned
47-48	Mains cumulative apparent energy	0.1	kVAh	Unsigned
49-50	Mains cumulative reactive energy	0.1	kvarh	Unsigned
51	Oil pressure	0.1	bar	Unsigned
52	Coolant temperature	0.1	°C	Unsigned
53	Fuel level	1	%	Unsigned
54	Fuel level in lit	0.1	lit	Unsigned
55	Charge alternator voltage	0.1	V	Unsigned
56	Battery voltage	0.1	V	Unsigned
57	Engine speed	1	RPM	Unsigned
58	No of starts	1	--	Unsigned
59	No of trips	1	--	Unsigned
60-61	Eng run hrs	1	Hrs	Unsigned
62	Eng run min	1	Min	Unsigned
63	Mains run hrs	1	Hrs	Unsigned
64	Mains run min	1	Min	Unsigned
65	Auxiliary input S1 value	0.1		Unsigned
66	Auxiliary input S2 value	0.1		Unsigned
67	Auxiliary input S3 value	0.1		Unsigned
68	Auxiliary input S4 value	0.1		Unsigned
69	BTS voltage	0.1		Unsigned
70	BTS run time hrs	1		Unsigned
71	BTS run time mins	1		Unsigned

Alarm status

Register address	Parameter	Scale Factor	Unit/ Interpretation	Bits/Sign
72	Alarm 1			
	Low oil pressure	--	--	13/16-16/16
	High coolant temperature	--	--	9/16-12/16
	Radiator water level/Low fuel level	--	--	5/16-8/16
	Reserved/Radiator water level switch	--	--	1/16-4/16
73	Alarm 2			
	Underspeed	--	--	13/16-16/16
	Overspeed	--	--	9/16-12/16
	Fail to start	--	--	5/16-8/16
	Fail to stop	--	--	1/16-4/16
74	Alarm 3			
	Generator low voltage/Reserved	--	--	13/16-16/16
	Generator high voltage/Reserved	--	--	9/16-12/16
	Generator low frequency	--	--	5/16-8/16
	Generator high	--	--	1/16-4/16
75	Alarm 4			
	Generator high current	--	--	13/16-16/16
	Generator overload	--	--	9/16-12/16
	Unbalanced load	--	--	5/16-8/16
	Emergency stop	--	--	1/16-4/16
76	Alarm 5			
	Charge alternator failure	--	--	13/16-16/16
	Oil filter maintenance/Filter maintenance	--	--	9/16-12/16
	Fuel filter maintenance/Reserved	--	--	5/16-8/16
	Air filter maintenance/Reserved	--	--	1/16-4/16
77	Alarm 6			
	Battery low voltage	--	--	13/16-16/16
	Battery high voltage	--	--	9/16-12/16
	Oil pressure circuit open/Engine temperature circuit open	--	--	5/16-8/16
	Reserved	--	--	1/16-4/16
78	Alarm 7			
	Fuel theft	--	--	13/16-16/16
	Magnetic pick up fault	--	--	9/16-12/16
	Oil pressure circuit	--	--	5/16-8/16
	Reserved	--	--	1/16-4/16

Register address	Parameter	Scale Factor	Unit/ Interpretation	Bits/Sign
79	Alarm 8			
	Auxiliary input A	--	--	13/16-16/16
	Auxiliary input B	--	--	9/16-12/16
	Auxiliary input C	--	--	5/16-8/16
	Auxiliary input D	--	--	1/16-4/16
80	Alarm 9			
	Auxiliary input E	--	--	13/16-16/16
	Auxiliary input F	--	--	9/16-12/16
	Auxiliary input G	--	--	5/16-8/16
	Auxiliary input H	--	--	1/16-4/16
81	Alarm 10			
	Auxiliary input I	--	--	13/16-16/16
	Auxiliary input J	--	--	9/16-12/16
	Auxiliary input K	--	--	5/16-8/16
	Auxiliary input L	--	--	1/16-4/16
82	Alarm 11			
	Auxiliary input M	--	--	13/16-16/16
	Auxiliary input N	--	--	9/16-12/16
	Auxiliary input O	--	--	5/16-8/16
	Auxiliary input P	--	--	1/16-4/16
83	Alarm 12			
	Gen L1 phase low volt	--	--	13/16-16/16
	Gen L1 phase high volt	--	--	9/16-12/16
	Gen L2 phase low volt	--	--	5/16-8/16
	Gen L2 phase high volt	--	--	1/16-4/16
84	Alarm 13			
	Gen L3 phase low volt	--	--	13/16-16/16
	Gen L3 phase high volt	--	--	9/16-12/16
	DG phase rotation	--	--	5/16-8/16
	Mains phase rotation	--	--	1/16-4/16
85	Alarm 14	--		
	Extended overload trip	--	--	13/16-16/16
	V belt broken	--	--	9/16-12/16
	Open fuel level	--	--	5/16-8/16
	High oil pressure detected	--	--	1/16-4/16

Register address	Parameter	Scale Factor	Unit/ Interpretation	Bits/Sign
86	Alarm 15	--		
	Auxiliary Input S4			13/16-16/16
	Auxiliary Input S3			9/16-12/16
	Auxiliary Input S2			5/16-8/16
	Auxiliary Input S1			1/16-4/16
87	Alarm 16			
	Auxiliary S4 open ckt alarm			13/16-16/16
	Auxiliary S3 open ckt alarm			9/16-12/16
	Auxiliary S2 open ckt alarm			5/16-8/16
	Auxiliary S1 open ckt alarm			1/16-4/16
88	Alarm 17			
	Auxiliary S4 over-current/over-voltage alarm			13/16-16/16
	Auxiliary S3 over-current/over-voltage alarm			9/16-12/16
	Unimplemented			5/16-8/16
	Unimplemented			1/16-4/16

Input and output status

Register address	Parameter	Scale Factor	Unit/ Interpretation	Bits/Sign
89	Input diagnostics			
	Digital input A	--	--	16/16
	Digital input B	--	--	15/16
	Digital input C	--	--	14/16
	Digital input D	--	--	13/16
	Digital input E	--	--	12/16
	Digital input F	--	--	11/16
	Digital input G	--	--	10/16
	Digital input H	--	--	9/16
	Digital input I	--	--	8/16
	Analog input J	--	--	7/16
	Analog input K	--	--	6/16
	Analog input L	--	--	5/16
	Auxiliary input M	--	--	4/16
	Auxiliary input N	--	--	3/16
	Auxiliary input O	--	--	2/16
	Auxiliary input P	--	--	1/16

Register address	Parameter	Scale Factor	Unit/ Interpretation	Bits/Sign
90	Output Diagnostics			
	Digital output A	--	--	16/16
	Digital output B	--	--	15/16
	Digital output C	--	--	14/16
	Digital output D	--	--	13/16
	Digital output E	--	--	12/16
	Digital output F	--	--	11/16
	Digital output G	--	--	10/16
	Unimplemented	--	--	9/16
	Unimplemented	--	--	8/16
	Unimplemented	--	--	7/16
	Unimplemented	--	--	6/16
	Unimplemented	--	--	5/16
	Unimplemented	--	--	4/16
	Unimplemented	--	--	3/16
	Unimplemented	--	--	2/16
	Unimplemented	--	--	1/16

Register address	Parameter	Scale Factor	Unit/ Interpretation	Bits/Sign
91	DG status			
	GCU Mode		Config Run	16/16
	Mains healthy/Unhealthy	--	True (1) False (0)	15/16
	DG operation mode	--	Scheduler Cyclic Auto Manual	14-12/16
	Load on DG		True (1) False (0)	11/16
	Load on Mains	--	True (1) False (0)	10/16
	Current DG status	--	Running Stopped	9/16
	DG stopped normally	--	True (1) False (0)	8/16
	DG stopped with fault		True (1) False (0)	7/16
	DG fail to start	--	True (1) False (0)	6/16
	Gen available		True (1) False (0)	5/16
	Common shut down	--	True (1) False (0)	4/16
	Common electric trip	--	True (1) False (0)	3/16
	Common warning	--	True (1) False (0)	2/16
	Common notification	--	True (1) False (0)	1/16
92	Current time stamp	--	Min Sec	Hexadecimal
93	Current time stamp		Week day Hour	Hexadecimal
94	Current time stamp		Month Day	Hexadecimal
95	Current time stamp		Year	Unsigned

Table 12.1 Example of Time stamp settings

Register address	Time	Hexadecimal	Decimal
92	Min	0x1215	Min = 0x12
	Sec		Sec = 0x15
93	Week day	0x0414	Week day = 0x04
	Hour		Hour = 0x0E

Register address	Time	Hexadecimal	Decimal
94	Month	0x0402	Month = 0x04
	Day		Day = 0x02
95	Year	-	2020

The time stamp is 14:18.21, Thursday, 02/04-2020.

12.3 Register map (function code 16)

Register map (function code 16)

Register offset	Description	Note	Bits/Sign
0	DG mode change command	SGC STOP KEY (0x01) SGC START KEY (0x02) SGC AUTO KEY (0x04) SGC ACK KEY (0x40)	Unsigned

13. Engine communication

13.1 Introduction to engine communication

Engine communication enables the SGC controller to communicate with different engine types over CAN bus. Some engine types only allow the SGC to read information from the engine's ECU, while other types also make it possible to regulate and transmit different commands to the ECU.

Engine communication protocols are typically based on the SAE J1939 standard. It is a very comprehensive standard, and just a small part is relevant for engine communication.

See the ECU user manuals for the ECU protocol technical description and details of each communication value.

Other engines and controllers

For engines and controllers not listed in this document, contact DEIF.

13.2 Default settings

The SGC controller is delivered with a set of default settings for engine communication. These settings are not necessarily correct for the specific engine/generator set. Check all the settings before running the engine/generator set.

13.3 Supported engines

The SGC controller uses the J1939 protocol to communicate with these engines:

Manufacturer	SGC can write commands
Generic J1939	Yes
Cummins	Yes
Deutz - EMR	Yes
Iveco	Yes
MTU	Yes
Scania	Yes
Volvo Penta	Yes

13.4 Engine values on the display

You can configure the SGC controller to show values from the ECU on the display.

Figure 13.1 Display example

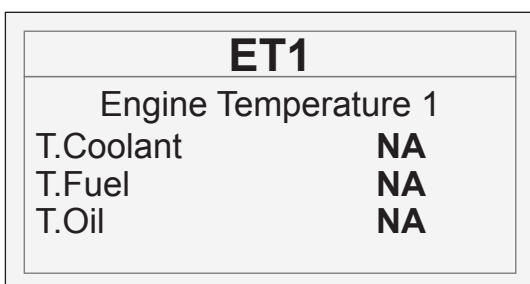

The image shows a display window with a title bar 'ET1'. Below the title bar, the text 'Engine Temperature 1' is displayed. Underneath, there are three rows of data: 'T.Coolant' with the value 'NA', 'T.Fuel' with the value 'NA', and 'T.Oil' with the value 'NA'.

ET1	
Engine Temperature 1	
T.Coolant	NA
T.Fuel	NA
T.Oil	NA

13.5 Engine communication settings

Use the DEIF Smart Connect software to configure engine communication in the SGC controller.

Open DEIF Smart Connect and connect to the SGC controller, then select **Start > Engine > Engine Control unit (ECU)** for the engine communication settings window.

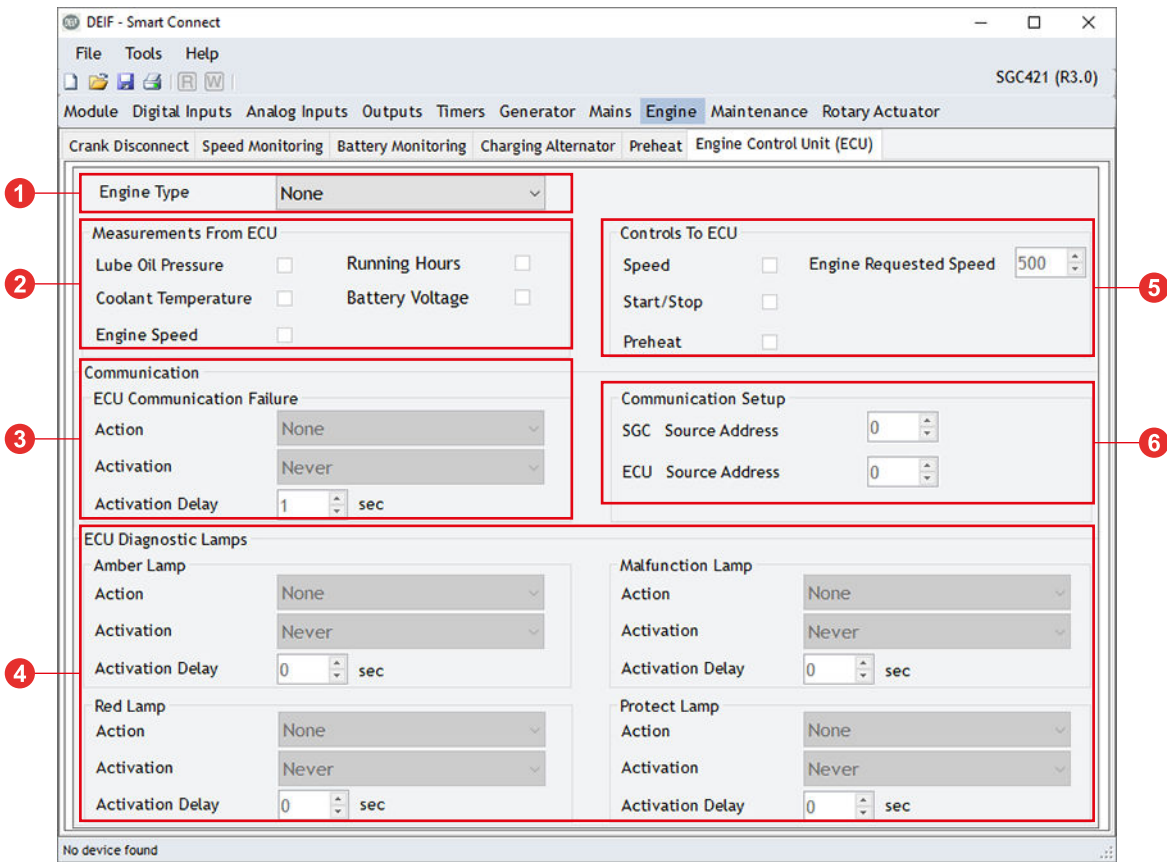

No.	Function
1	Select the engine type from the drop-down list.
2	Select types of measurements from the engine/ECU.
3	Configure the settings for the ECU communication failure alarm.
4	Configure the settings for the diagnostic lamps on the ECU <ul style="list-style-type: none"> • Amber lamp • Red lamp • Malfunction lamp • Protect lamp See the specific documentation for the engine/ECU for more information.
5	Select the actions that SGC controls for the engine/ECU <ul style="list-style-type: none"> • Engine speed • Engine start/stop • Engine preheat
6	Configure source addresses for the SGC controller and the engine/ECU. See the specific documentation for the engine/ECU for information about the source address.

13.6 Generic J1939

Basic information

- Engine controller/type: Any controller which uses generic J1939.
- DEIF Smart Connect: Select Generic J1939.
- Complies with the J1939 standard.
- Baud rate: 250 kb/s



Warnings and shutdowns

These standard warnings and shutdowns are supported:

- EIC yellow lamp
- EIC red lamp
- EIC malfunction
- EIC protection

Displaying alarms

The display can show J1939 diagnostic messages DM1 (active alarms) and DM2 (historic alarm log list). You can acknowledge these alarms from the display unit. For some engines, the display has a special alarm display (see the specific engine type).

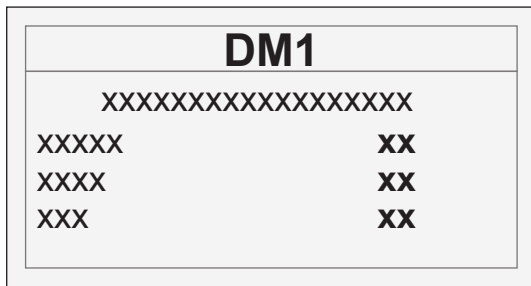

Press the *Down*  button for 4 seconds to see the alarm log. By default, the alarm log shows the DM1 (active alarms). To see the historical alarm list, use *Down*  button to select DM2.



Alarm log DM1 shows active alarms



Alarm log DM2 shows historic alarms

- Scroll through the alarm list with the *Up*  and *Down*  buttons.
- **oc##**: Shows how many times a specific alarm has occurred.
- **CLRALL**: Press ENTER to clear the entire alarm log list. For safety reasons, this requires the master password.



NOTE

If the controller has no translation text for an SPN diagnostic number, Text N/A is shown. For information about particular SPN numbers, see the engine manufacturer's documentation. Alternatively, see SAE J1939-71 for a general description.

J1939 write commands

Command	Description
Speed control	The CAN bus ID for speed control is 0xC000003. J1939 TSC1 (transmission rate is 10 ms).
EIC start/stop	This is a more advanced function than the standard J1939 Start/Stop commands. See the M-Logic commands for details. If the M-Logic command is enabled, the SGC can also send the standard J1939 start/stop command. The controller determines whether to start or stop the engine. The decision is based on the SGC's inputs, logic and calculations.

TSC1 SA Torque Speed Control

Torque Speed Control 1 (TSC1) is the speed control signal from the SGC to the ECU. For known protocols, the SGC uses the expected source address when TSC1 SA is -1 (default value). You can configure the controller for a specific source address (the range is 0 to 255). Ask the engine manufacturer to verify the TSC1 source address.

13.7 Wiring



More information

See the **Installation** chapter for more information about wiring.

14. CAN communication

14.1 About the CAN communication protocol

SGC 410 supports a CAN based protocol, which is used to read measurement values, status of alarms and derived calculations (such as cumulative power), as well as to send mode change and start/stop commands to the controller.

Connection details:

- Baud rate used for communication is 250 kbps
- ID of the controller is fixed to 0x01
- ID scheme for CAN communication is Standard ID (not extended ID)
- Packet size used for communication is 8 bytes

14.2 CAN communication structure

The controller continuously broadcasts measurement values, status of alarms and commands, and derived calculations. Additionally, a set of commands can be sent to the controller. Response to the commands is a part of the data that is broadcast.

Communication structure, page 0

Register offset	Value	Scale factor	Unit	Bits/Sign
0	Protocol revision	-	-	Unsigned
1	Generator L1-N voltage	1	V	Unsigned
2	Generator L2-N voltage	1	V	Unsigned

Communication structure, page 1

Register offset	Value	Scale factor	Unit	Bits/Sign
3	Generator L2-L3 voltage	1	V	Unsigned
4	Generator L1-L2 voltage	1	V	Unsigned
5	Generator L3-N voltage	1	V	Unsigned

Communication structure, page 2

Register offset	Value	Scale factor	Unit	Bits/Sign
6	Generator L3-L1 voltage	1	V	Unsigned
7	Generator L2 frequency	1	Hz	Unsigned
8	Generator L1 frequency	1	Hz	Unsigned

Communication structure, page 3

Register offset	Value	Scale factor	Unit	Bits/Sign
9	Generator power factor L2	1	-	Unsigned
10	Generator L3 frequency	1	Hz	Unsigned
11	Generator power factor L1	1	-	Unsigned

Communication structure, page 4

Register offset	Value	Scale factor	Unit	Bits/Sign
12	Mains L1-N voltage	1	V	Unsigned
13	Generator power factor L3	1	-	Unsigned
14	Generator average power factor	1	-	Unsigned

Communication structure, page 5

Register offset	Value	Scale factor	Unit	Bits/Sign
15	Mains L1-L2 voltage	1	V	Unsigned
16	Mains L2-N voltage	1	V	Unsigned
17	Mains L3-N voltage	1	V	Unsigned

Communication structure, page 6

Register offset	Value	Scale factor	Unit	Bits/Sign
18	Mains L1 frequency	1	Hz	Unsigned
19	Mains L2-L3 voltage	1	V	Unsigned
20	Mains L3-L1 voltage	1	V	Unsigned

Communication structure, page 7

Register offset	Value	Scale factor	Unit	Bits/Sign
21	Load L1 current	1	A	Unsigned
22	Mains L2 frequency	1	Hz	Unsigned
23	Mains L3 frequency	1	Hz	Unsigned

Communication structure, page 8

Register offset	Value	Scale factor	Unit	Bits/Sign
24	Load L1 watts	1	kW	Unsigned
25	Load L2 current	1	A	Unsigned
26	Load L3 current	1	A	Unsigned

Communication structure, page 9

Register offset	Value	Scale factor	Unit	Bits/Sign
27	Load total watts	1	kW	Unsigned
28	Load L2 watts	1	kW	Unsigned
29	Load L3 watts	1	kW	Unsigned

Communication structure, page 10

Register offset	Value	Scale factor	Unit	Bits/Sign
30	Load L2 VA	1	kVA	Unsigned
31	Percentage Load	10	kW	Unsigned
32	Load L1 VA	1	kVA	Unsigned

Communication structure, page 11

Register offset	Value	Scale factor	Unit	Bits/Sign
33	Load L1 VAR	1	kvar	Unsigned
34	Load L3 VA	1	kVA	Unsigned
35	Load total VA	1	kVA	Unsigned

Communication structure, page 12

Register offset	Value	Scale factor	Unit	Bits/Sign
36	Load L2 VAR	1	kvar	Unsigned
37	Load L3 VAR	1	kvar	Unsigned
38	Load total VAR	1	kvar	Unsigned

Communication structure, page 13

Register offset	Value	Scale factor	Unit	Bits/Sign
39-40	Generator cumulative energy	0.1	kWh	Unsigned

Communication structure, page 14

Register offset	Value	Scale factor	Unit	Bits/Sign
41-42	Generator cumulative apparent energy	0.1	kVAh	Unsigned

Communication structure, page 15

Register offset	Value	Scale factor	Unit	Bits/Sign
43-44	Generator cumulative reactive energy	0.1	kvarh	Unsigned

Communication structure, page 16

Register offset	Value	Scale factor	Unit	Bits/Sign
45-46	Mains cumulative energy	0.1	kWh	Unsigned

Communication structure, page 17

Register offset	Value	Scale factor	Unit	Bits/Sign
47-48	Mains cumulative apparent energy	0.1	kVAh	Unsigned

Communication structure, page 18

Register offset	Value	Scale factor	Unit	Bits/Sign
49-50	Mains cumulative reactive energy	0.1	kvarh	Unsigned
51	Oil pressure	1	bar	Unsigned

Communication structure, page 19

Register offset	Value	Scale factor	Unit	Bits/Sign
52	Fuel in lit	1	l	Unsigned
53	Coolant temperature	1	°C	Unsigned
54	Fuel level	1	%	Unsigned

Communication structure, page 20

Register offset	Value	Scale factor	Unit	Bits/Sign
55	Charge alternator voltage	1	V	Unsigned
56	Battery voltage	1	V	Unsigned
57	Engine speed	1	RPM	Unsigned

Communication structure, page 21

Register offset	Value	Scale factor	Unit	Bits/Sign
58	No of starts	1	-	Unsigned
59	No of trips	1	-	Unsigned
60	Eng run hrs	1	hrs	Unsigned

Communication structure, page 22

Register offset	Value	Scale factor	Unit	Bits/Sign
61	Eng run min	1	min	Unsigned
62	Mains run hrs	1	hrs	Unsigned
63	Mains run min	1	min	Unsigned

Communication structure, page 23

Register offset	Value	Scale factor	Unit	Bits/Sign
64	Alarm 1			
	Low oil pressure	-	E-0001/0001 W-0010/0010 S-0011/0011	3/16-16/16
	High coolant temperature	-	E-0001/0001 W-0010/0010 S-0011/0011	9/16-12/16
	Radiator water level/low fuel level	-	E-0001/0001 N-0101/0101S-0 011/0011	5/16-8/16
	Water level switch	-	E-0001/0001 N-0101/0101 W-0010/0010 E-0100/0100 S-0011/0011	1/16-4/16
65	Alarm 2			
	Under speed	-	E-0001/0001 S-0011/0011	13/16-16/16
	Over speed	-	E-0001/0001 S-0011/0011	9/16-12/16
	Fail to start	-	E-0001/0001 S-0011/0011	5/16-8/16
	Fail to stop	-	E-0001/0001 S-0011/0011	1/16-4/16

Register offset	Value	Scale factor	Unit	Bits/Sign
66	Alarm 3			
	Reserved	-	1111	13/16-16/16
	Reserved	-	1111	9/16-12/16
	Generator low frequency	-	E-0001/0001 W-0010/0010 S-0011/0011	5/16-8/16
	Generator high	-	E-0001/0001 W-0010/0010 S-0011/0011	1/16-4/16

Communication structure, page 24

Register offset	Value	Scale factor	Unit	Bits/Sign
67	Alarm 4			
	Generator high current	-	E-0001/0001 N-0101/0101 W-0010/0010 E-0100/0100 S-0011/0011	13/16-16/16
	Generator overload	-	E-0001/0001 N-0101/0101 W-0010/0010 E-0100/0100 S-0011/0011	9/16-12/16
	Unbalanced load	-	E-0001/0001 N-0101/0101 W-0010/0010 E-0100/0100 S-0011/0011	5/16-8/16
	Emergency stop	-	E-0001/0001 S-0011/0011	1/16-4/16
68	Alarm 5			
	Charge alternator failure	-	E-0001/0001 N-0101/0101 W-0010/0010 E-0100/0100 S-0011/0011	13/16-16/16
	Maintenance	-	E-0001/0001 N-0101/0101 W-0010/0010	9/16-12/16
	Reserved	-	1111	5/16-8/16
	Reserved	-	1111	1/16-4/16

Register offset	Value	Scale factor	Unit	Bits/Sign
69	Alarm 6			
	Battery low voltage	-	E-0001/0001 N-0101/0101 W-0010/0010 E-0100/0100 S-0011/0011	13/16-16/16
	Battery high voltage	-	E-0001/0001 N-0101/0101 W-0010/0010 E-0100/0100 S-0011/0011	9/16-12/16
	Temperature circuit open	-	E-0001/0001 N-0101/0101 W-0010/0010 E-0100/0100 S-0011/0011	5/16-8/16
	Reserved	-	1111	1/16-4/16

Communication structure, page 25

Register offset	Value	Scale factor	Unit	Bits/Sign
70	Alarm 7			
	Fuel theft	-	-	13/16-16/16
	Magnetic pick up fault	-	E-0001/0001 S-0011/0011	9/16-12/16
	Oil pressure circuit	-	E-0001/0001 N-0101/0101 W-0010/0010 E-0100/0100 S-0011/0011	5/16-8/16
	Auxiliary input I	-	E-0001/0001 N-0101/0101 W-0010/0010 E-0100/0100 S-0011/0011	1/16-4/16

Register offset	Value	Scale factor	Unit	Bits/Sign
71	Alarm 8			
	Auxiliary input A		E-0001/0001 N-0101/0101 W-0010/0010 E-0100/0100 S-0011/0011	13/16-16/16
	Auxiliary input B		E-0001/0001 N-0101/0101 W-0010/0010 E-0100/0100 S-0011/0011	9/16-12/16
	Auxiliary input C		E-0001/0001 N-0101/0101 W-0010/0010 E-0100/0100 S-0011/0011	5/16-8/16
	Auxiliary input D		E-0001/0001 N-0101/0101 W-0010/0010 E-0100/0100 S-0011/0011	1/16-4/16
72	Alarm 9			
	Auxiliary input E	-	E-0001/0001 N-0101/0101 W-0010/0010 E-0100/0100 S-0011/0011	13/16-16/16
	Auxiliary input F	-	E-0001/0001 N-0101/0101 W-0010/0010 E-0100/0100 S-0011/0011	9/16-12/16
	Auxiliary input G	-	E-0001/0001 N-0101/0101 W-0010/0010 E-0100/0100 S-0011/0011	5/16-8/16
	Auxiliary input H	-	E-0001/0001 N-0101/0101 W-0010/0010 E-0100/0100 S-0011/0011	1/16-4/16

Register offset	Value	Scale factor	Unit	Bits/Sign
73	Alarm 10			
	Gen L1 phase low volt	-	E-0001/0001 W-0010/0010 S-0011/0011	13/16-16/16
	Gen L1 phase high volt	-	E-0001/0001 W-0010/0010 S-0011/0011	9/16-12/16
	Gen L2 phase low volt	-	E-0001/0001 W-0010/0010 S-0011/0011	5/16-8/16
	Gen L2 phase high volt	-	E-0001/0001 W-0010/0010 S-0011/0011	1/16-4/16
74	Alarm 11			
	Gen L3 phase low volt	-	E-0001/0001 W-0010/0010 S-0011/0011	13/16-16/16
	Gen L3 phase high volt	-	E-0001/0001 W-0010/0010 S-0011/0011	9/16-12/16
	DG phase rotation	-	E-0001/0001 N-0101/0101 W-0010/0010 E-0100/0100 S-0011/0011	5/16-8/16
	Mains phase rotation	-	E-0001/0001 N-0101/0101	1/16-4/16
75	Alarm 12			
	Fuel level open circuit	-	E-0001/0001 N-0101/0101 W-0010/0010 E-0100/0100 S-0011/0011	13/16-16/16
	V belt broken	-	E-0001/0001 N-0101/0101 W-0010/0010 E-0100/0100 S-0011/0011	9/16-12/16
	Extended overload trip	-	E-0001/0001 S-0011/0011	5/16-8/16
	High oil pressure detected	-	E-0001/0001 W-0010/0010	1/16-4/16

Communication structure, page 27

Register offset	Value	Scale factor	Unit	Bits/Sign
76	Input/output diagnostics			
	Digital input A	-	1/0	16/16
	Digital input B	-	1/0	15/16
	Digital input C	-	1/0	14/16
	Digital input D	-	1/0	13/16
	Digital input E	-	1/0	12/16
	Digital input F	-	1/0	11/16
	Digital input G	-	1/0	10/16
	Digital input H	-	1/0	9/16
	Digital input I	-	1/0	8/16
	Digital output A	-	1/0	7/16
	Digital output B	-	1/0	6/16
	Digital output C	-	1/0	5/16
	Digital output D	-	1/0	4/16
	Digital output E	-	1/0	3/16
	Digital output F	-	1/0	2/16
	Unimplemented	-	-	1/16

Register offset	Value	Scale factor	Unit	Bits/Sign
77	DG status			
	Controller mode	-	Config (1) Run (0)	16/16
	Mains healthy/unhealthy	-	True (1) False (0)	15/16
	DG operation mode	-	Scheduler-110 Cyclic-111 Auto-101 Manual-100	14-12/16
	Load on Mains	-	True (1) False (0)	11/16
	Load on DG	-	True (1) False (0)	10/16
	Current DG status	-	Running Stopped	9/16
	DG stopped normally	-	True (1) False (0)	8/16
	DG stopped with fault	-	True (1) False (0)	7/16
	DG fail to start	-	True (1) False (0)	6/16
	Gen available	-	True (1) False (0)	5/16
	Common shutdown	-	True (1) False (0)	4/16
	Common electric trip	-	True (1) False (0)	3/16
	Common warning	-	True (1) False (0)	2/16
	Common notification	-	True (1) False (0)	1/16

Communication structure, page 28

Register offset	Value	Scale factor	Unit	Bits/Sign
78-81	Current time stamp			

Structure of broadcast message

Byte no.	Byte contents
0	Page ID
1	Data at offset 0 - high byte
2	Data at offset 0 - low byte
3	Data at offset 1 - high byte
4	Data at offset 1 - low byte
5	Data at offset 2 - high byte
6	Data at offset 2 - low byte
7	Reserved

Structure of command message

Byte no.	Byte contents
0	Command ID
1	Command parameters
2	Reserved
3	Reserved
4	Reserved
5	Reserved
6	Reserved
7	Reserved

14.3 CAN packet structure

Structure of command message received over CAN:

Command ID	Description	Command parameter (each of 1 Bytes)	Bits/ Sign
1	Start/Stop command	0x01 - Start DG 0x02 - Stop DG Command status is updated in status register	Unsigned
2	Operating mode change command	0x01 - Toggle the current mode of operation between Auto mode and Manual mode Auto mode operates the DG remotely Manual mode operates the DG through key-press events	Unsigned

15. Troubleshooting

15.1 Troubleshooting

Table 15.1 General troubleshooting

Fault	Action
The controller does not power ON.	<ul style="list-style-type: none"> • Check the battery voltage. • Check the fuse on the battery supply. • Check continuity between battery positive and controller terminal 2. • Check continuity between battery ground and controller terminal 1.
The controller display freezes.	<ul style="list-style-type: none"> • Reset the controller power.
The controller fails to crank-start the engine.	<ul style="list-style-type: none"> • Check the battery voltage. • Enter the Configuration mode in the controller and verify the configuration for the Start output. Check that the Start output is working correctly by measuring its output voltage. • Enter the Configuration mode in the controller and verify the configuration of the Crank disconnect method. Verify the configuration of the LLOP Switch polarity. Ensure that the lube oil pressure switch and sensor are working OK. Check their wiring.
The Emergency stop alarm is shown without the Emergency stop is activated.	<ul style="list-style-type: none"> • Check if the Emergency stop switch is working OK, including the wiring. • Enter the Configuration mode in the controller and verify the configuration of the Emergency stop polarity.
The controller generates unnecessary Shutdown alarms or Warning alarms.	<ul style="list-style-type: none"> • Check the respective switch, sensor and wiring. • Enter the Configuration mode in the controller and verify the respective threshold configuration.
The controller shows Charging Alt Fail alarm.	<ul style="list-style-type: none"> • To check if the controller's charging alternator terminal is working: <ul style="list-style-type: none"> ◦ Disconnect the charging alternator wiring to the controller's terminal 10. ◦ Short the terminal 10 to the ground through a DC ammeter. ◦ Crank-start the engine. ◦ The DC ammeter should indicate the current in the range of 200 to 400 mA for ~30 seconds. ◦ If yes, the controller's charging alternator terminal is working OK. • Disconnect and re-connect the charging alternator ind connection to the controller's terminal 10. • Check if the charging alternator is working OK.
The controller shows Error C03.	<p>Error C03 can occur if the controller is disconnected from the PC during a configuration.</p> <ol style="list-style-type: none"> 1. Press and hold the <i>Stop/Config</i>  button during a power cycle to reset the controller. 2. Re-send the configuration file.
<ol style="list-style-type: none"> 1. The controller shows the genset is ON while the genset is stopped. 2. The controller shows the Fail to stop alarm when the genset is at rest. 	<ul style="list-style-type: none"> • Enter the Configuration mode in the controller and verify the configuration for the LLOP and LOP. Check the wiring. • Ensure that the mains voltage wiring is not connected by mistake to the controller's genset voltage terminals.
The controller sends a Crank-start command immediately after power on.	<ul style="list-style-type: none"> • Ensure that the controller's output terminal is not directly connected to the starter relay. The controller's output should be given to an intermediate relay which should in-turn power the starter relay. The controller can get permanently damaged and will need to be replaced if this precaution is not taken. • Check start-relay connection with the suitable controller terminal. • Enter the Configuration mode in the controller and verify the configuration for Start mode and the Start relay output polarity.

Fault	Action
The engine runs, but the controller shows the genset to be OFF.	<ul style="list-style-type: none"> • Check the alternator voltage signal (L1 phase) is received by the controller terminal. • Check if the LOP and LLOP are working OK. Check the wiring to the controller.
The controller shows incorrect PF value or kW or load current.	<ul style="list-style-type: none"> • Check wiring of the respective alternator phase voltage and the CT to the controller. • Check the CT ratio (if kW or current reading is faulty).
The controller shows incorrect reading for any of LOP, fuel level or engine temperature sensors.	<ul style="list-style-type: none"> • Check respective sensor and its wiring. • Check the SCP wiring. • Enter the Configuration mode in the controller and verify the calibration for the respective sensor in the configuration.

Table 15.2 Auto mode troubleshooting

Fault	Action
The controller shows incorrect engine RPM.	<ul style="list-style-type: none"> • Check the wiring of the main alternator's L1-phase and neutral to the controller.
The controller does not start the engine when a Remote start command is sent from an external device.	<ul style="list-style-type: none"> • Check the wiring of the Remote start signal to the controller's respective digital input terminal. • Enter the Configuration mode in the controller and verify the configuration for the Remote start digital input terminal. • Check that the controller is in Auto mode. • Check for Mains monitoring disabled and Site mode disabled.
Controller does not stop the engine when a Remote stop command is sent from an external device.	<ul style="list-style-type: none"> • Check the wiring of the Remote stop signal to the controller's respective digital input terminal. • Enter the Configuration mode in the controller and verify the configuration for the Remote stop digital input terminal. • Check that the controller is in Auto mode.

Table 15.3 Modbus troubleshooting

Fault	Action
The controller is not sending data via the Modbus communication	<ul style="list-style-type: none"> • Check if the Modbus communication is enabled in the controller. • Check if the Modbus communication settings of slave match with the master. • Check if the connections are done properly for the Modbus input (terminals 31 and 32). • Check if the connections are interchanged. • Check the 120 Ω resistance between terminal A (terminal 31) and terminal B (terminal 32).

Table 15.4 Site monitoring troubleshooting

Fault	Action
Site voltage is observed continuously varying.	<ul style="list-style-type: none"> • Check if panel and Site are properly earthed. • Check if the connections are done properly for the differential input (terminals 24 and 25).