



-power in control



DESIGNER'S REFERENCE HANDBOOK



Generator Paralleling Controller GPC-3/GPC-3 Gas/GPC-3 Hydro

- Functional description
- Modes and sequences
- General product information
- PID controller
- Additional functions



DEIF A/S · Frisenborgvej 33 · DK-7800 Skive
Tel.: +45 9614 9614 · Fax: +45 9614 9615
info@deif.com · www.deif.com

Document no.: 4189340587L
SW version: 3.09.x or later

1. General information

1.1. Warnings, legal information and safety.....	5
1.1.1. Warnings and notes	5
1.1.2. Legal information and disclaimer	5
1.1.3. Safety issues	5
1.1.4. Electrostatic discharge awareness	5
1.1.5. Factory settings	6
1.2. About the designer's reference handbook.....	6
1.2.1. General purpose	6
1.2.2. Intended users	6
1.2.3. Contents and overall structure	6

2. General product information

2.1. General product information.....	7
2.1.1. Introduction.....	7
2.1.2. Type of product.....	7
2.1.3. Options.....	7
2.1.4. PC utility software warning.....	7

3. Functional descriptions

3.1. Standard functions.....	8
3.2. Regulation modes.....	9
3.3. Fixed frequency.....	9
3.4. Fixed power.....	10
3.5. Frequency droop.....	10
3.6. P load sharing.....	12
3.7. Measurement systems.....	13
3.7.1. Three-phase system.....	13
3.7.2. Single phase system.....	14
3.7.3. Split phase system.....	14
3.8. Scaling.....	15
3.9. Single-line diagrams.....	16
3.10. Sequences.....	18
3.10.1. Sequences.....	18
3.11. Running mode description.....	21
3.11.1. Running mode description.....	21
3.12. Password.....	21
3.12.1. Parameter access.....	23

4. Additional functions

4.1. Start functions.....	24
4.1.1. Start/stop threshold.....	24
4.2. Alarm.....	25
4.2.1. Alarm function.....	25
4.2.2. Alarm inhibit.....	29
4.2.3. Alarm jump.....	31
4.2.4. Alarm test mode.....	31
4.3. Breaker.....	31
4.3.1. Breaker types.....	31
4.3.2. Breaker spring load time.....	31
4.4. Differential measurement.....	32
4.5. Digital inputs.....	35
4.5.1. Functional description	37
4.6. Multi-inputs.....	42
4.6.1. 4 to 20 mA.....	43
4.6.2. 0 to 40 V DC.....	43
4.6.3. Pt100/1000.....	43
4.6.4. RMI inputs.....	43

4.6.5. RMI oil.....	43
4.6.6. RMI water.....	44
4.6.7. RMI fuel.....	45
4.6.8. Illustration of configurable inputs.....	46
4.6.9. Configuration.....	47
4.6.10. Scaling of 4 to 20 mA inputs.....	47
4.6.11. Digital.....	50
4.7. Event log.....	50
4.7.1. Logs.....	50
4.8. External set points.....	52
4.8.1. External analogue set point.....	52
4.8.2. Scaling of analogue inputs for external set point control	53
4.8.3. External set point selection.....	56
4.9. Fail class.....	58
4.9.1. Fail class configuration.....	59
4.10. Frequency-dependent power droop.....	60
4.11. Language selection.....	63
4.11.1. Language selection.....	63
4.12. Memory backup.....	64
4.12.1. Memory backup.....	64
4.13. Load sharing.....	64
4.13.1. Load sharing.....	64
4.14. Power limit set point.....	70
4.14.1. Four-stage power limit set point.....	70
4.15. M-Logic.....	70
4.16. Mode configuration.....	71
4.16.1. Manual mode.....	71
4.16.2. Not in remote.....	72
4.16.3. Modes active.....	72
4.17. Nominal settings.....	73
4.18. Relay setup.....	74
4.18.1. Limit relay.....	75
4.19. Service menu.....	77
4.19.1. Service menu.....	77
4.20. Step-up and step-down transformer.....	81
4.20.1. Step-up transformer.....	81
4.20.2. Vector group for step-up transformer	82
4.20.3. Setup of step-up transformer and measurement transformer	89
4.20.4. Vector group for step-down transformer	90
4.20.5. Setup of step-down transformer and measurement transformer	92
5. Protections	
5.1. Protections.....	94
5.1.1. General.....	94
5.2. Inverse time over-current.....	96
5.3. Reverse power.....	99
5.4. Trip of Non-Essential Load (NEL).....	100
5.5. Reset ratio (hysteresis).....	101
6. PID controller	
6.1. PID controller.....	102
6.2. Proportional regulator.....	103
6.3. Relay control.....	108
7. Synchronisation	
7.1. General information.....	111
7.2. Dynamic synchronisation.....	111
7.2.1. Close signal.....	112
7.2.2. Load picture after synchronising.....	112

7.3. Static synchronisation.....	114
7.3.1. Phase controller.....	115
7.4. Synchronising controller.....	116
7.5. Synchronising vector mismatch alarm.....	117
7.6. Asynchronous synchronisation	118
7.7. Blackout closing	118
7.8. Separate synchronising relay.....	119
7.9. Inhibit conditions before synchronising mains breaker.....	121

1. General information

1.1 Warnings, legal information and safety

1.1.1 Warnings and notes

Throughout this document, a number of warnings and notes with helpful user information will be presented. To ensure that these are noticed, they will be highlighted as follows in order to separate them from the general text.

Warnings

 **Warnings indicate a potentially dangerous situation, which could result in death, personal injury or damaged equipment, if certain guidelines are not followed.**

Notes

 **Notes provide general information, which will be helpful for the reader to bear in mind.**

1.1.2 Legal information and disclaimer

DEIF takes no responsibility for installation or operation of the generator set. If there is any doubt about how to install or operate the engine/generator controlled by the Multi-line 2 unit, the company responsible for the installation or the operation of the set must be contacted.

 **The Multi-line 2 unit is not to be opened by unauthorised personnel. If opened anyway, the warranty will be lost.**

Disclaimer

DEIF A/S reserves the right to change any of the contents of this document without prior notice.

The English version of this document always contains the most recent and up-to-date information about the product. DEIF does not take responsibility for the accuracy of translations, and translations might not be updated at the same time as the English document. If there is a discrepancy, the English version prevails.

1.1.3 Safety issues

Installing and operating the Multi-line 2 unit may imply work with dangerous currents and voltages. Therefore, the installation should only be carried out by authorised personnel who understand the risks involved in working with live electrical equipment.

 **Be aware of the hazardous live currents and voltages. Do not touch any AC measurement inputs as this could lead to injury or death.**

1.1.4 Electrostatic discharge awareness

Sufficient care must be taken to protect the terminal against static discharges during the installation. Once the unit is installed and connected, these precautions are no longer necessary.

1.1.5 Factory settings

The Multi-line 2 unit is delivered from factory with certain factory settings. These are based on average values and are not necessarily the correct settings for matching the engine/generator set in question. Precautions must be taken to check the settings before running the engine/generator set.

1.2 About the designer's reference handbook

1.2.1 General purpose

This Designer's Reference Handbook mainly includes functional descriptions, presentation of display unit and menu structure, information about the PID controller, the procedure for parameter setup and reference to parameter lists.

The general purpose of this document is to provide useful overall information about the functionality of the unit and its applications. This document also offers the user the information he needs in order to successfully set up the parameters needed in his specific application.



Make sure to read this document before starting to work with the Multi-line 2 unit and the gen-set to be controlled. Failure to do this could result in human injury or damage to the equipment.

1.2.2 Intended users

This Designer's Reference Handbook is mainly intended for the panel builder designer in charge. On the basis of this document, the panel builder designer will give the electrician the information he needs in order to install the Multi-line 2 unit, for example detailed electrical drawings. In some cases, the electrician may use these installation instructions himself.

1.2.3 Contents and overall structure

This document is divided into chapters, and in order to make the structure simple and easy to use, each chapter will begin from the top of a new page.

2. General product information

2.1 General product information

2.1.1 Introduction

This chapter will deal with the unit in general and its place in the DEIF product range.

The GPC-3 is part of the DEIF Multi-line 2 product family. Multi-line 2 is a complete range of multi-function generator protection and control products integrating all the functions you need into one compact and attractive solution.

2.1.2 Type of product

The Generator Paralleling Controller is a microprocessor-based control unit containing all necessary functions for protection and control of a generator.

It contains all necessary 3-phase measuring circuits, and all values and alarms are presented on the LCD display.

2.1.3 Options

The Multi-line 2 product range consists of different basic versions which can be supplemented with the flexible options needed to provide the optimum solution. The options cover, for example, various protections for generator, busbar and mains, voltage/var/PF control, various outputs, serial communication, and so on.



A complete list of available options is included in the data sheet, document no. 4921240351; refer to www.deif.com.

2.1.4 PC utility software warning



It is possible to remote-control the genset from the PC utility software, by use of a modem or TCP/IP. To avoid personal injury, make sure that it is safe to remote-control the genset.

3. Functional descriptions

3.1 Standard functions

The standard functions are listed in the following paragraphs.

Regulation modes

- Load sharing
- Fixed frequency
- Fixed power
- Frequency droop

Generator protection (ANSI)

- 2 × reverse power (32)
- 5 × overload (32)
- 6 × over-current (50/51)
- Inverse time over-current (51)
- 2 × over-voltage (59)
- 3 × under-voltage (27)
- 3 × over-/under-frequency (81)
- Voltage-dependent over-current (51V)
- Current/voltage unbalance (60)
- Loss of excitation/overexcitation (40/32RV)

Busbar protection (ANSI)

- 3 × over-voltage (59)
- 4 × under-voltage (27)
- 3 × over-frequency (81)
- 4 × under-frequency (81)
- Voltage unbalance (60)
- 3 × NEL groups

M-Logic (Micro PLC)

- Simple logic configuration tool
- Selectable input/output events

Display

- Status texts
- Info messages
- Alarm indication
- Prepared for remote mounting
- Prepared for additional remote displays

General

- USB interface to PC
- Free PC utility software
- Programmable parameters, timers and alarms
- User configurable texts

3.2 Regulation modes

The unit can, for example, be used for the applications listed in the table below. This depends on the selection of the running modes.

Mode selection	Select regulation mode			
	Fixed frequency	Fixed power	Droop	Load sharing
Application				
Island mode, stand-alone	X		X	
Island mode, load sharing with other gensets			X	X
Fixed power, for example to mains		X	X	

 Regulation modes can be selected via digital inputs, M-Logic or the external communication protocols.

3.3 Fixed frequency

This regulation mode is typically used when the generator is running in island operation/stand-alone. During island operation/stand-alone, the load connected to the generator cannot be changed through regulation of the genset. If the fuel supply to the engine is increased or decreased, the loading of the genset does not change – only the frequency will increase or decrease as a result of changed fuel supply.

Dependency

Fixed frequency mode is active when:

Input/Active mode			Fixed frequency (sync.)	Fixed frequency	Fixed frequency
Control inputs	Start sync./control	25	ON	ON	ON
	De-load	43	OFF	ON	OFF
Breaker feedbacks	GB open	26	ON	ON	OFF
	GB closed	27	OFF	OFF	ON
Mode inputs	Fixed frequency	48	<i>Mode inputs are not used when the GB is open</i>		ON

 To activate the use of “Start sync./control” from M-Logic or external communication (for example Modbus), the M-Logic command “Start sync./ctrl enable” must be activated. Alternatively, you can use the functions “Remote GB ON” and “Remote GB OFF”.

 Never mix the two control methods! If “Remote GB ON/OFF” control is used, you must unconfigure “Start sync./control”, and vice versa.

Regulator

The frequency regulator is active in this mode. During fixed frequency operation, the set point is typically the nominal frequency.

3.4 Fixed power

This regulation mode is typically used when the generator is running parallel to the mains. During fixed power operation, the genset cannot change the frequency because it is maintained by the grid. If the fuel supply to the engine is increased or decreased, the frequency of the genset does not change – only the load will increase or decrease as a result of changed fuel supply.

Dependency

Fixed power mode is active when:

Input			Active mode	
			Fixed power (w/sync.)	Fixed power (de-load)
Control inputs	Start sync./control	25	ON	ON
	De-load	43	OFF	ON
Breaker feedbacks	GB open	26	OFF	OFF
	GB closed	27	ON	ON
Mode inputs	Fixed P	User def.	ON	ON

 To activate the use of “Start sync./control” from M-Logic or external communication (for example Modbus), the M-Logic command “Start sync./ctrl enable” must be activated. Alternatively, you can use the functions “Remote GB ON” and “Remote GB OFF”.

 Never mix the two control methods! If “Remote GB ON/OFF” control is used, you must unconfigure “Start sync./control”, and vice versa.

Regulator

The power regulator is active in this mode. During fixed power operation, the set point is typically adjusted in the display (menu 7051).

3.5 Frequency droop

This regulation mode can be used on various occasions where it is required that the generator frequency drops with increasing load.

 The governor droop has the purpose of applying stability in the regulation of the engine and does not give an actual droop if a controller (GPC-3) is installed.

 The GPC-3 droop has the purpose of causing an actual speed droop. With this droop activated, the frequency will actually change with changing load.

Diagram A: high droop setting

In this diagram, the illustrated frequency variation gives a change in the load. This is marked as ΔP .

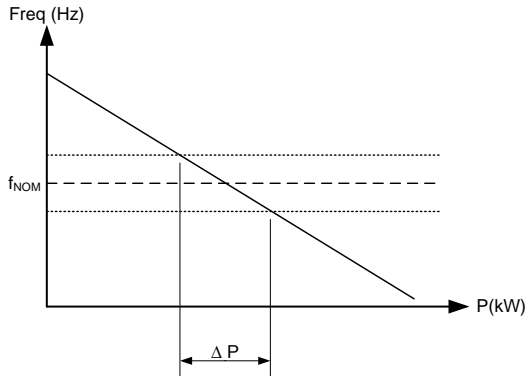

This can be used if the generator must operate base-loaded.

Diagram B: low droop setting

In this diagram, the load change (ΔP) is larger than before. This means that the generator will vary more in loading than with the higher droop setting.

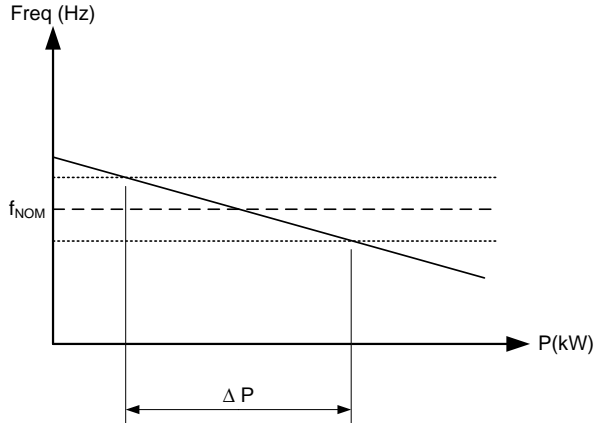

This can be used if the generator must operate as a peak load machine.

Load sharing with older types of gensets

Droop mode can be used when a new genset is installed in an installation where old gensets are installed and they operate in droop mode. Then it can be preferred to install the new genset and operate it in droop mode in order to make equal load sharing with the existing gensets.

Compensation for isochronous governors

When the genset is equipped with a governor that only provides isochronous operation, the droop in the GPC-3 can be used to compensate for the missing droop setting possibility on the governor.

Dependency

Droop mode is active when:

Input			Active mode
			Droop
Control inputs	Start sync./control	25	ON
	De-load	43	OFF
Breaker feedbacks	CB open	54	OFF
	CB closed	55	ON
Mode inputs	Frequency droop	User def.	ON



To activate the use of “Start sync./control” from M-Logic or external communication (for example Modbus), the M-Logic command “Start sync./ctrl enable” must be activated. Alternatively, you can use the functions “Remote GB ON” and “Remote GB OFF”.

Regulator

The frequency controller is used in the GPC-3 when operating in frequency droop mode. This means that as long as the power does not match the frequency, the governor will be controlled up- or downwards. In this way, the power and the frequency will always end up matching each other according to the adjusted droop curve.



3.6 P load sharing

This regulation mode is typically used when paralleling two or more gensets. During load sharing operation with other gensets, the power and frequency of each individual genset can be changed. This means that if the fuel supply is changed to the engine, the power of the genset – and subsequently the frequency – will change.

Dependency



P load sharing mode is active when:

Input			Active mode
			Load sharing
Control inputs	Start sync./control	25	ON
	De-load	43	OFF
Breaker feedbacks	GB open	26	OFF
	GB closed	27	ON
Mode inputs	P load sharing	49	ON

-  To activate the use of “Start sync./control” from M-Logic or external communication (for example Modbus), the M-logic command “Start sync./ctrl enable” must be activated. Alternatively, you can use the functions “Remote GB ON” and “Remote GB OFF”.
-  Never mix the two control methods! If “Remote GB ON/OFF” control is used, you must unconfigure “Start sync./control”, and vice versa.
-  In case the busbar frequency drops more than the setting in menu 2623 during de-load, the GB will be opened regardless of the setting in menu 2622 (Breaker open point).

Regulator

The power and the frequency regulators are active when the load sharing mode is selected. The set point is typically a combination of the signal on the load sharing line and the nominal frequency.

-  For a detailed description of the load sharing principle, refer to the chapter “Load sharing”.
-  Analogue load sharing: When a unit is running alone on the busbar, the regulation mode should be changed to fixed frequency.

Governor mode undefined (menu 2730)

After the breaker has been closed, it is required that one regulation mode is selected. In case no mode is selected or more than one mode is selected, the following action will be performed regardless of the fail class selected for “GOV mode undef.” in 2730:

1. No mode input active: The unit is changed to manual mode (regulator OFF), and a “GOV mode undef.” alarm is raised after the delay has expired.
2. More than one mode input active: The unit is maintained in the first selected running mode and the “GOV mode undef.” alarm is raised.

3.7 Measurement systems

The GPC is designed for measurement of voltages between 100 and 690 V AC on the terminals. If the voltage is higher, voltage transformers are required. For further reference, the AC wiring diagrams are shown in the Installation Instructions.

In menu 9130, the measurement principle can be changed; the options are three-phase, single phase and split phase.

-  Configure the GPC to match the correct measuring system. When in doubt, contact the switch-board manufacturer for information about the required adjustment.

3.7.1 Three-phase system

When the GPC is delivered from the factory, the three-phase system is selected. When this principle is used, all three phases must be connected to the GPC.

The table below contains the parameters to make the system ready for split phase measuring.

Below is an example with 230/400 V AC, which can be connected directly to the GPC's terminals without the use of a voltage transformer. If a voltage transformer is necessary, the nominal values of the transformer should be used instead.

Setting	Adjustment	Description	Adjust to value
6004	G nom. voltage	Phase-phase voltage of the generator	400 V AC
6041	G transformer	Primary voltage of the G voltage transformer (if installed)	400 V AC
6042	G transformer	Secondary voltage of the G voltage transformer (if installed)	400 V AC
6051	BB transformer set 1	Primary voltage of the BB voltage transformer (if installed)	400 V AC
6052	BB transformer set 1	Secondary voltage of the BB voltage transformer (if installed)	400 V AC
6053	BB nom. voltage set 1	Phase-phase voltage of the busbar	400 V AC

 The GPC has two sets of BB transformer settings, which can be enabled individually in this measurement system.

3.7.2 Single phase system

The single phase system consists of one phase and the neutral.

The table below contains the parameters to make the system ready for single phase measuring.

Below is an example with 230 V AC, which can be connected directly to the GPC's terminals without the use of a voltage transformer. If a voltage transformer is necessary, the nominal values of the transformer should be used instead.

Setting	Adjustment	Description	Adjust to value
6004	G nom. voltage	Phase-neutral voltage of the generator	230 V AC
6041	G transformer	Primary voltage of the G voltage transformer (if installed)	230 V AC
6042	G transformer	Secondary voltage of the G voltage transformer (if installed)	230 V AC
6051	BB transformer set 1	Primary voltage of the BB voltage transformer (if installed)	230 V AC
6052	BB transformer set 1	Secondary voltage of the BB voltage transformer (if installed)	230 V AC
6053	BB nom. voltage set 1	Phase-neutral voltage of the busbar	230 V AC

 The voltage alarms refer to U_{NOM} (230 V AC).

 The GPC has two sets of BB transformer settings, which can be enabled individually in this measurement system.

3.7.3 Split phase system

This is a special application where two phases and neutral are connected to the GPC. The GPC shows phases L1 and L3 in the display. The phase angle between L1 and L3 is 180 degrees. Split phase is possible between L1-L2 or L1-L3.

The table below contains the parameters to make the system ready for split phase measuring. Below is an example with 240/120 V AC, which can be connected directly to the GPC's terminals without the use of a voltage transformer. If a voltage transformer is necessary, the nominal values of the transformer should be used instead.

Setting	Adjustment	Description	Adjust to value
6004	G nom. voltage	Phase-neutral voltage of the generator	120 V AC
6041	G transformer	Primary voltage of the G voltage transformer (if installed)	120 V AC
6042	G transformer	Secondary voltage of the G voltage transformer (if installed)	120 V AC
6051	BB transformer set 1	Primary voltage of the BB voltage transformer (if installed)	120 V AC
6052	BB transformer set 1	Secondary voltage of the BB voltage transformer (if installed)	120 V AC
6053	BB nom. voltage set 1	Phase-neutral voltage of the busbar	120 V AC

 The measurement U_{L3L1} shows 240 V AC. The voltage alarm set points refer to the nominal voltage 120 V AC, and U_{L3L1} does not activate any alarm.

 The GPC has two sets of BB transformer settings, which can be enabled individually in this measurement system.

3.8 Scaling

Default voltage scaling for the GPC-3 is set to 100 V-25000 V. To be able to handle applications above 25000 V and below 100 V, it is necessary to adjust the input range so it matches the actual value of the primary voltage transformer. This makes it possible for the GPC-3 to support a wide range of voltage and power values.

Setup of the scaling can be done from the display by using the jump function or by using the USW.

 When changing the voltage scaling in menu 9030, the unit will reset. If it is changed via the USW, it is necessary to read the parameter again.

Scaling of nominal voltage and voltage read-out is done in menu 9030.

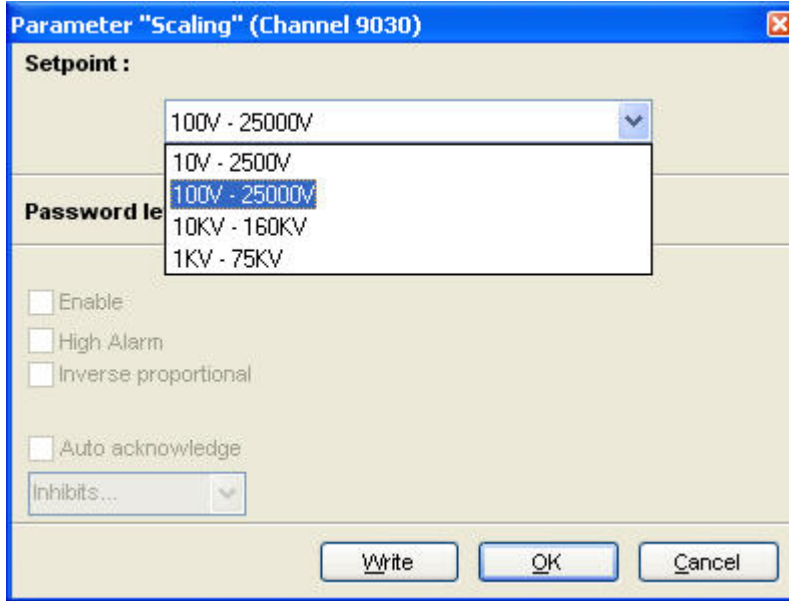

Changing the voltage scaling will also influence the nominal power scaling:

Scaling parameter 9030	Nom. settings 1 to 4 (power)	Nom. settings 1 to 4 (voltage)	Menu: 6041, 6051 and 6053
10 V-2500 V	1.0-900.0 kW	10.0 V-2500.0 V	10.0 V-2500.0 V
100 V-25000 V	10-20000 kW	100 V-25000 V	100 V-25000 V
1 kV-75 kV	0.10-90.00 MW	1.00 kV-75.00 kV	1.00 kV-75.00 kV
10 kV-160 kV	1.0-900.0 MW	10.0 kV-160.0 kV	10.0 kV-160.0 kV

3.9 Single-line diagrams

The GPC-3 can be used for numerous applications. A few examples are shown below, but due to the flexibility of the product it is not possible to show all applications. The flexibility is one of the great advantages of this controller.

Stand-alone

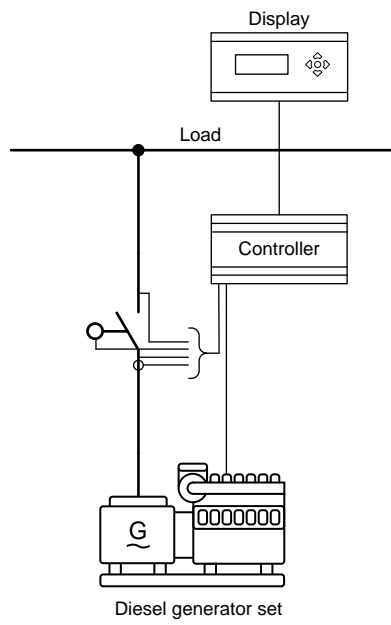

Parallel to mains

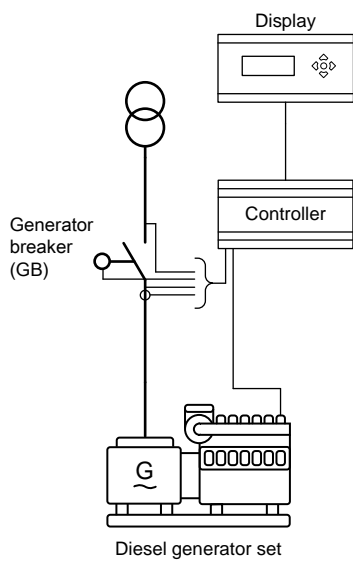

Paralleling gensets (load sharing)

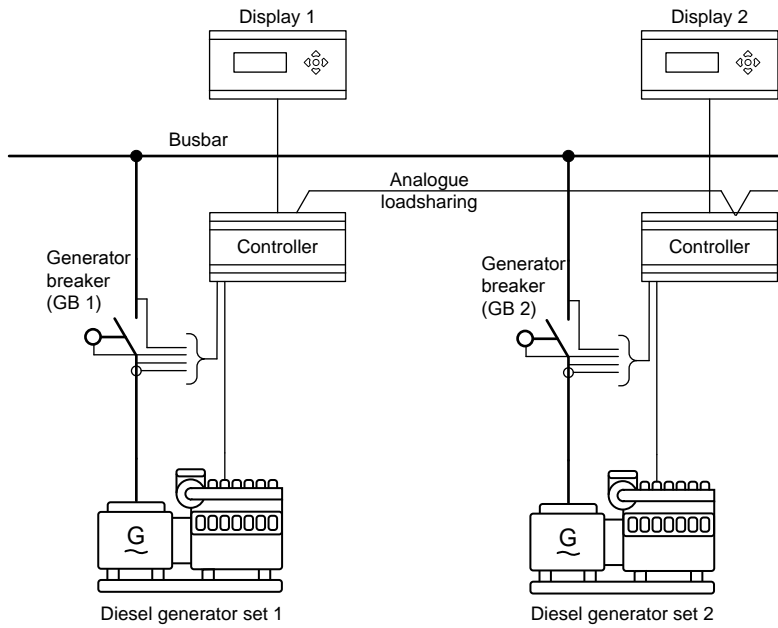

PLC-controlled system

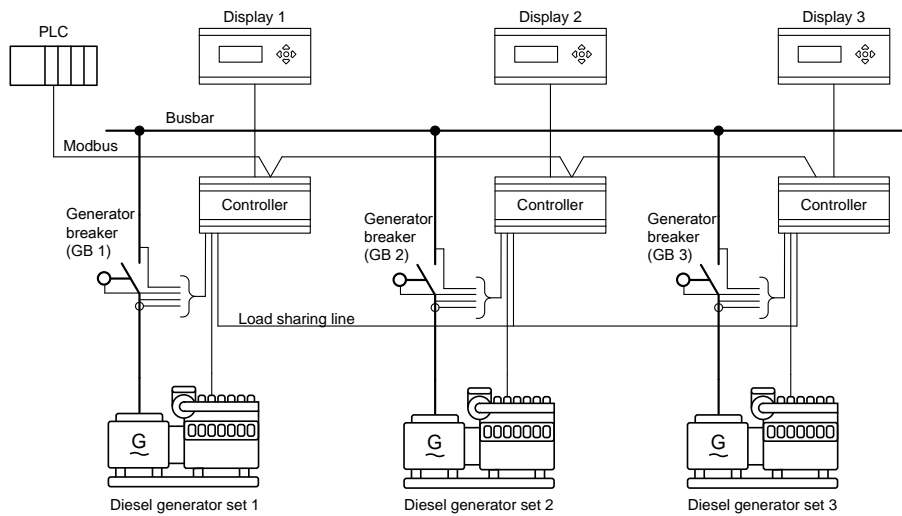

3.10 Sequences

3.10.1 Sequences

The following section contains information about the sequences of the GPC-3.

These sequences will be described:

Sequence	Description
GB ON	Synchronising
GB ON	Blackout closing
GB OFF	Open breaker
GB OFF	De-load/open breaker

GB ON sequence/synchronising

The GB ON sequence can be started when the generator is running and the terminal 25 (start sync./control) is activated. The regulation will start and control the genset in order to synchronise the breaker.

 **The busbar voltage must be above $70\% \times U_{NOM}$ in order to initiate the synchronising.**

Interruption of the GB ON (synchronising) sequence	
Input 25 deactivated	
Input 43 activated	25 = ON at the same time
Remote GB ON activated	
GB close	
UBB measured below 70 %	$70\% \times U_{NOM}$
Synchronising failure	
GB close failure	
Alarm with Safety stop, Trip GB or Block fail class	

 **When the GB opens, there is a 10 s delay that prevents it from closing immediately after it has opened. This is to ensure that there is sufficient time to change mode and control inputs.**

GB ON sequence/blackout closing

In order to make a blackout closing, terminal 25 must be activated and the measurements from the busbar must be missing. The breaker will close if the generator voltage is within the settings of 2110 sync. blackout.

 **The busbar voltage must be below $30\% \times U_{NOM}$ in order to initiate the black busbar closing.**

Interruption of the GB ON (blackout close) sequence	
Input 25 deactivated	
Input 43 activated	25 = ON at the same time
Remote GB ON activated	
U gen. not OK	Limit set in menu 2112
f gen. not OK	Limit set in menu 2111
Black closing not enabled	Input function configured and input not activated
GB close	
UBB measured above 30 %	
General failure	
Alarm with Safety stop, Trip GB or Block fail class	



When the GB opens, there is a 10 s delay that prevents it from closing immediately after it has opened. This is to ensure that there is sufficient time to change mode and control inputs.

GB OFF/open breaker

The GB can be opened instantly by the GPC-3. The sequence is started by this selection of the control inputs:

Terminal	Description	Input state	
25	Start sync./control	ON	ON
43	De-load	ON	ON
48	Fixed frequency	ON	OFF
User def.	Frequency droop	OFF	ON

The GB open signal will be issued immediately when the combination of the control inputs are as mentioned in the table above.

GB OFF/de-load

The GB can be opened by the GPC-3 after a smooth de-load period where the load has decreased to the breaker open point (menu 2622). The sequence is started by one of the following combinations of inputs:

Terminal	Description	Input state	
25	Start sync./control	ON	ON
43	De-load	ON	ON
49	Load sharing	ON	OFF
User def.	Fixed P	OFF	ON

The GB open signal will be issued when the load has been below the breaker open point for 1 second. In order to interrupt the de-load sequence, the input 43 must be deactivated. Then the GPC-3 will continue the operation according to the present mode selection. The de-load sequence can also be interrupted if the input "Start sync./control" is deactivated. But then the entire regulation is deactivated.

Remote GB ON

The generator breaker ON sequence will be initiated and the breaker will synchronise if voltage and frequency at the BB are OK, or close without synchronising if the BB voltage is below $30\% \times U_{NOM}$.

Remote GB OFF

The generator breaker OFF sequence will be initiated. Whether the breaker is de-loaded before opening depends on the active regulation mode.

Mode	De-load	Comment
Fixed frequency	No	GB will be opened immediately
Frequency droop	No	
P load sharing	Yes	GB will be de-loaded to the GB open point (menu 2622) In case de-load is not possible, the breaker will be opened when BB frequency has dropped to $f_{NOM} - 0.5$ Hz
Fixed P	Yes	GB will be de-loaded to the GB open point (menu 2622)

3.11 Running mode description

3.11.1 Running mode description

Local mode

In local mode, the sequences must be activated with the display push-buttons, and all external commands are ignored.

The following sequences can be activated in local mode:

Command	Description
Close GB	The unit will synchronise and close the generator breaker. If the busbar is black, the unit will close the GB directly (no sync.)
Open GB	The unit will de-load and open the generator breaker at the breaker open point

Remote mode

In remote mode, the command push-buttons are ignored and the sequences must be activated with commands given in two ways:

1. Digital inputs are used
2. Modbus/Profibus commands are used

Fixed mode

In parameter 6141, it is possible to select between the following three settings: OFF (default), LOCAL or OFF. If this parameter is set to either LOCAL or REMOTE, the unit will be locked into this mode. If the user tries to change mode via an input or from the display, the following message will appear in the display: "Mode selection blocked".

It is also possible to lock the unit into a specific mode from M-Logic. Refer to the document "ML-2 application notes M-Logic".



The standard GPC-3 is equipped with a limited number of digital inputs; refer to the installation instructions and the data sheet for additional information about availability.

3.12 Password

Password level

The unit includes three password levels. All levels can be adjusted in the PC software.

Available password levels:

Password level	Factory setting	Access		
		Customer	Service	Master
Customer	2000	X		
Service	2001		X	
Master	2002	X	X	X

A parameter cannot be entered with a password that is ranking too low. But the settings can be displayed without password entry.

Each parameter can be protected by a specific password level. To do so, the PC utility software must be used. Enter the parameter to be configured and select the correct password level.

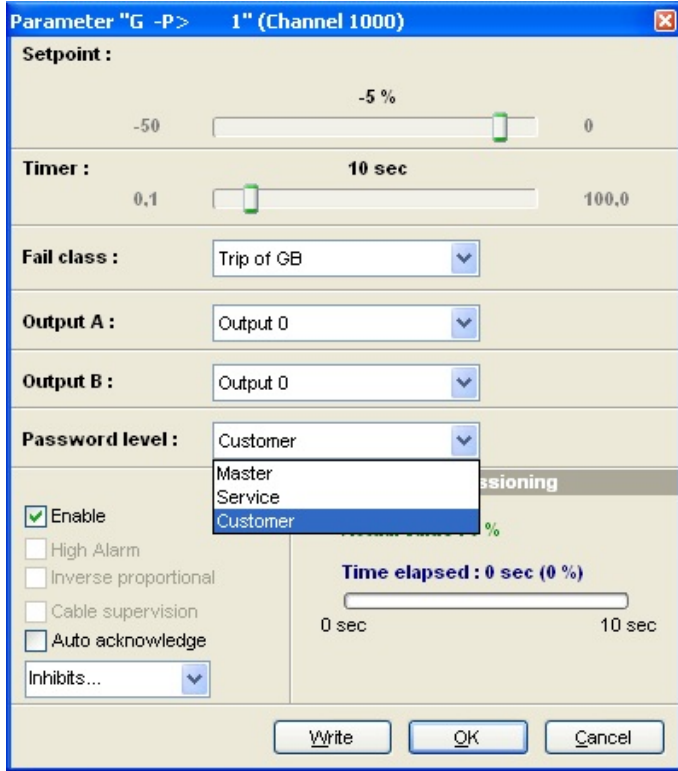

The password level can be seen in the parameter view in the column "Level":

OutputA	OutputB	Enabled	High alarm	Level	FailClass
0	0	<input checked="" type="checkbox"/>		Customer	Trip GB
0	0	<input checked="" type="checkbox"/>		Master	Trip GB
0	0	<input checked="" type="checkbox"/>		Service	Warning
0	0	<input checked="" type="checkbox"/>		Customer	Trip GB
0	0	<input checked="" type="checkbox"/>		Customer	Trip GB
0	0	<input checked="" type="checkbox"/>		Customer	Trip GB



A red arrow points to the "Level" column in the table.

3.12.1 Parameter access

To gain access to adjust the parameters, the password level must be entered:



If the password level is not entered, it is not possible to enter the parameters.

-  **The customer password can be changed in jump menu 9116. The service password can be changed in jump menu 9117. The master password can be changed in jump menu 9118.**
-  **The factory passwords must be changed if the operator of the genset is not allowed to change the parameters.**
-  **It is not possible to change the password at a higher level than the password entered.**

4. Additional functions

4.1 Start functions

4.1.1 Start/stop threshold

Start threshold allows the user to create a scenario, in which an external requirement must be met before start is possible. If the external requirements are met, stop threshold stops the DG immediately when in "cooling down" mode.

Access the external measurement by using one of the multi-inputs and, in parameters 6185 and 6213, apply the specific multi-input to use for the start/stop threshold function.

In parameters 6186 and 6214, you can enable/disable the start and stop threshold function and adjust the set point.

In addition, the alarm can either be set to high (checked) or low (unchecked). If "High Alarm" is checked, the measured external value must exceed the set point before start is possible, or before immediate stop when the "cooling down" timer is counting.

If "High Alarm" is unchecked, start/stop is possible when the measured value is under the set point.

Parameter "Start threshold" (Channel 6186)

Setpoint : 0 0 °C 300

Password level : customer

Enable

High Alarm

Inverse proportional

Auto acknowledge

Inhibits...

Write OK Cancel

The diagram below shows an example, in which the RMI signal builds up slowly, and starting is initiated at the end of the third start attempt.

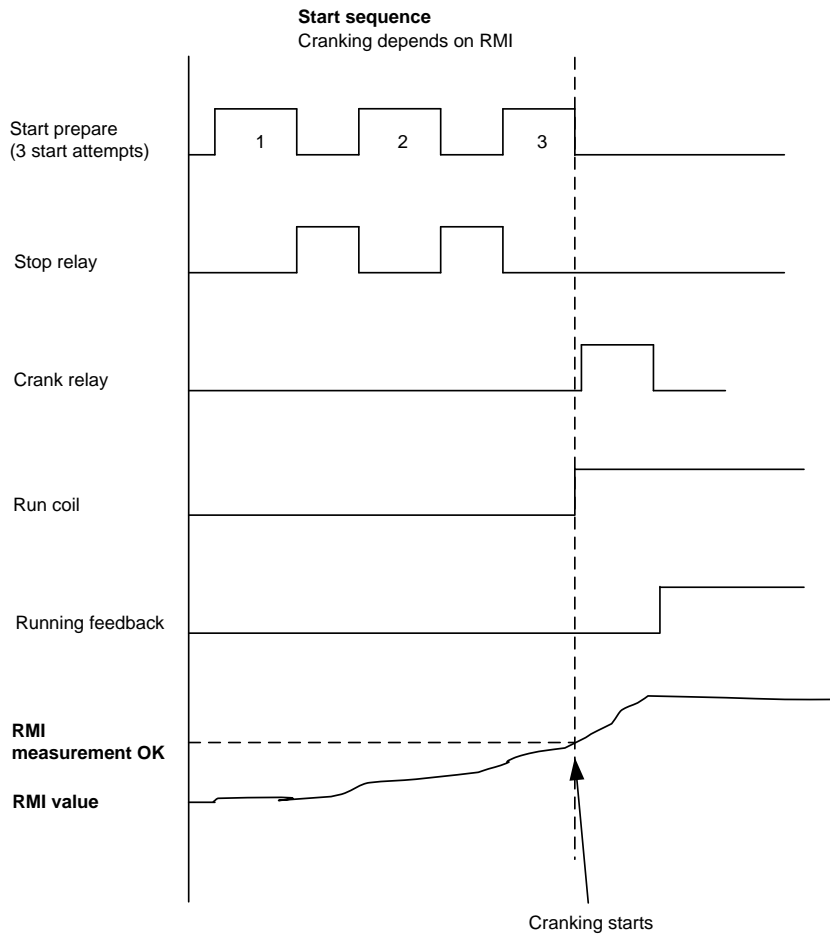

4.2 Alarm

4.2.1 Alarm function

The alarm function of the GPC-3 includes the possibility to display the alarm texts, activate relays or display alarm texts combined with relay outputs.

Setup

The alarms must typically be set up with set point, timer, relay outputs and enabling. The adjustable set points of the individual alarms vary in range, for example the minimum and maximum settings.

USW 3 setup:

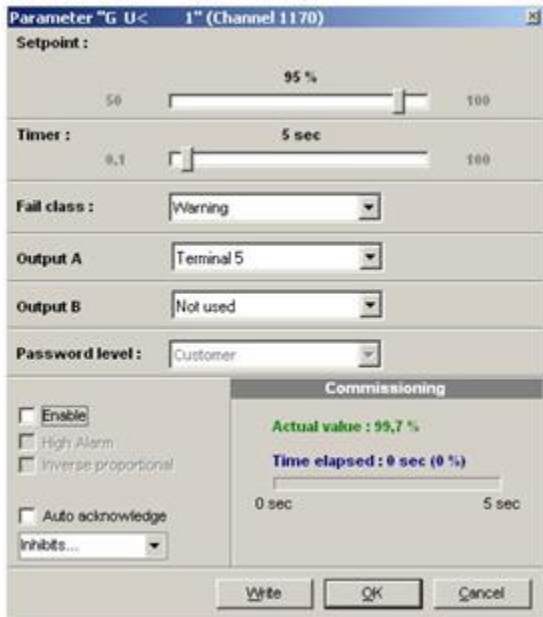

DU-2 setup:

G	0	0	0V
1170	G	U<	1
Relay 5			
SP	DEL	OA	OB ENA FC

SP = set point. DEL= timer. OA = output A. OB = output B. ENA = enable. FC = fail class.

Alarm display

All enabled alarms will be shown in the display, unless the output A as well as the output B are adjusted to a "limit" relay.

 If output A and output B are adjusted to a limit relay, then the alarm message will not appear but the limit relay will activate at a given condition.

Definitions

There are three states for an enabled alarm.

1	Alarm is not present:	The display does not show any alarm. The alarm LED is dark.
2	Unacknowledged state:	The alarm has exceeded its set point and delay, and the alarm message is displayed. The GPC-3 is in the alarm state, and it can only leave the alarm state if the cause of the alarm disappears and the alarm message is acknowledged at the same time. The alarm LED is flashing.
3	Acknowledged state:	The alarm will be in an acknowledged state if the alarm situation is present and the alarm has been acknowledged. The alarm LED is lit with fixed light. Any new alarm will make the LED flash.

Alarm acknowledge

The alarms can be acknowledged in two ways, either by means of the binary input “Alarm acknowledge” or the push-buttons on the display.

Digital acknowledge input

The alarm acknowledge input acknowledges all present alarms, and the alarm LED will change from flashing light to fixed light (alarms still present) or no light (no alarms present).



It is not possible to acknowledge individual alarms with the binary alarm acknowledge input. All alarms will be acknowledged when the input is activated.

Display acknowledge (push-buttons)

The display can be used for alarm acknowledgement when the alarm info window is entered. Pressing the “INFO” button will open this window.

The alarm information window displays one alarm at a time together with the alarm state (alarm acknowledged or not). If the alarm is unacknowledged, move the cursor to “ACK” and press select to acknowledge it.

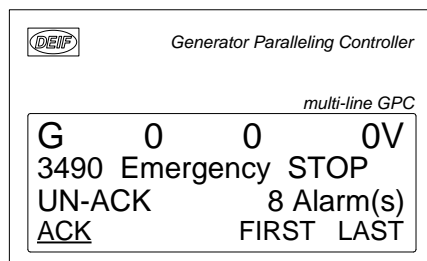

Use the  and  push-buttons to scroll through the alarm list. The alarm list contains all present alarms.

Relay outputs

In addition to the display message of the alarms, each alarm can also activate one or two relays if this is required.



Adjust output A (OA) and/or output B (OB) to the desired relay(s).

In the example in the drawing below, three alarms are configured and relays 1 to 4 are available as alarm relays.

When alarm 1 appears, output A activates relay 1 (R1) which activates an alarm horn on the diagram. Output B of alarm 1 activates relay 2 (R2). In the diagram, R2 is connected to the alarm panel.

Alarm 2 activates R1 and R4.

Alarm 3 activates R1 and R4.



Several alarms can activate the same relay.



Each alarm can activate none, one or two relays. (None means that only a display message is given.)

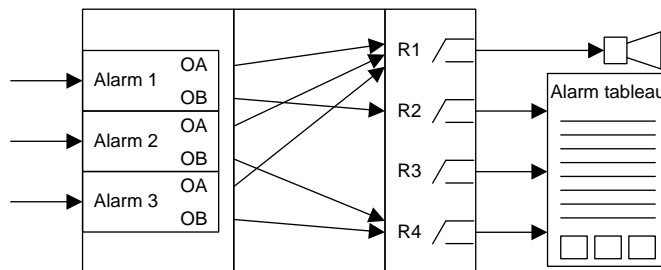

4.2.2 Alarm inhibit

In order to select when the alarms are to be active, a configurable **inhibit** setting for each alarm has been made. The inhibit functionality is only available via the PC utility software. For each alarm there is a drop-down window, in which it is possible to select the signals that must be present in order to inhibit the alarm.

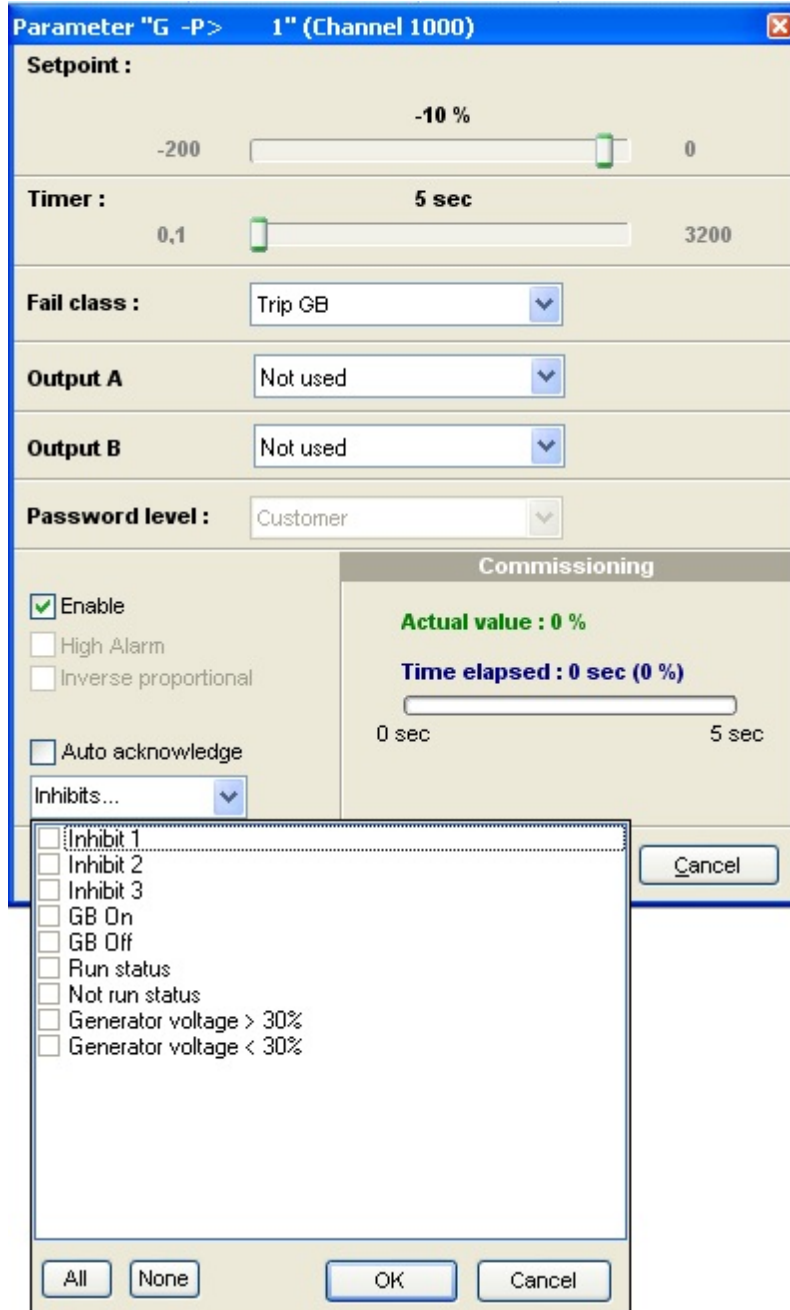

Selections for alarm inhibit:

Function	Description
Inhibit 1	Input function (alarm inhibit 1) or M-Logic output
Inhibit 2	M-Logic outputs: Conditions are programmed in M-Logic
Inhibit 3	
GB ON	The generator breaker is closed
GB OFF	The generator breaker is open
Run status	Running detected and the timer in menu 6160 expired
Not run status	Running not detected or the timer in menu 6160 not expired
Generator voltage > 30 %	Generator voltage is above 30 % of nominal
Generator voltage < 30 %	Generator voltage is below 30 % of nominal



The timer in 6160 is not used if digital running feedback is used

Inhibit of the alarm is active as long as one of the selected inhibit functions is active.

Inhibit 1
 Inhibit 2
 Inhibit 3
 GB On
 GB Off
 Run status
 Not run status
 Generator voltage > 30%
 Generator voltage < 30%

In this example, inhibit is set to **Not run status** and **GB On**. Here, the alarm will be active when the generator has started. When the generator has been synchronised to the busbar, the alarm will be disabled again



The inhibit LED on the base unit will activate when one of the inhibit functions is active.



Function inputs such as running feedback, remote start or access lock are never inhibited. Only alarm inputs can be inhibited.

4.2.3 Alarm jump

The **alarm jump** function is used to select the behaviour of the display view when an alarm is activated.

Setup is done in menu 6900 Alarm jump:

Enable	Action when an alarm is activated
ON (default)	The display view will change to the alarm info list.
OFF	The display view will stay at the present view.

4.2.4 Alarm test mode

To be able to test alarms and associated fail classes, an alarm test mode can be activated in menu 9050.

4.3 Breaker

4.3.1 Breaker types

There are three possible selections for the setting of the GB type (menu 6233).

Continuous

This type of signal is most often used combined with a contactor. When using this type of signal, the GPC will only use the close breaker relays. The relay will be closed for closing of the contactor and will be opened for opening of the contactor.



If continuous breaker is selected, relay 14 will become configurable.

Pulse (default setting)

This type of signal is most often used with a motorised circuit breaker. With the setting pulse, the GPC will use the close command and the open command relay. The close breaker relay will close for a short time for closing of the circuit breaker. The open breaker relay will close for a short time for opening of the breaker.

Compact

This type of signal will most often be used with a compact breaker, a direct-controlled motor-driven breaker. With the setting compact, the GPC will use the close command and the open command relay. The close breaker relay will close for a short time for the compact breaker to close. The breaker off relay will close for the compact breaker to open and hold it closed long enough for the motor in the breaker to recharge the breaker. If the compact breaker is tripped externally, it is recharged automatically before next closing.



If compact breaker is selected, the length of the breaker open signal can be adjusted. This can be done in menu 2160.

4.3.2 Breaker spring load time

To avoid breaker close failures in situations where breaker ON command is given before the breaker spring has been loaded, the spring load time can be adjusted for the GB.

The following describes a situation where you risk getting a close failure:

1. The genset is in remote mode, the "Start sync./control" input is active, the genset is running and the GB is closed.

2. The de-load input is activated and the GB is opened.
3. If the de-load input is deactivated again, the GB will give a GB close failure as the GB needs time to load the spring before it is ready to close.

Different breaker types are used, and therefore there are two available solutions:

1. Timer-controlled

A load time set point for the GB control for breakers with no feedback indicating that the spring is loaded. After the breaker has been opened, it will not be allowed to close again before the delay has expired. The set point is found in menu 6230.

2. Digital input

A configurable input to be used for feedbacks from the breaker. After the breaker has been opened it will not be allowed to close again before the configured input is active. The input is configured in the ML-2 utility software.

If the two solutions are used together, both requirements are to be met before closing of the breaker is allowed.

Breaker LED indication

To alert the user that the breaker close sequence has been initiated, but is waiting for permission to give the close command, the LED indication for the breaker will be flashing yellow in this case.

4.4 Differential measurement



Differential measurement requires option H5, H7, H8.x, M4 or M15.x.

The differential measurements are all of the definite time type, that is two set points and timer are activated.

If, for example, the differential function is fuel filter check, the timer will be activated if the set point between P_A (analogue A) and P_B (analogue B) is exceeded. If the differential value drops below the set point value before the timer runs out, the timer will be stopped and reset.

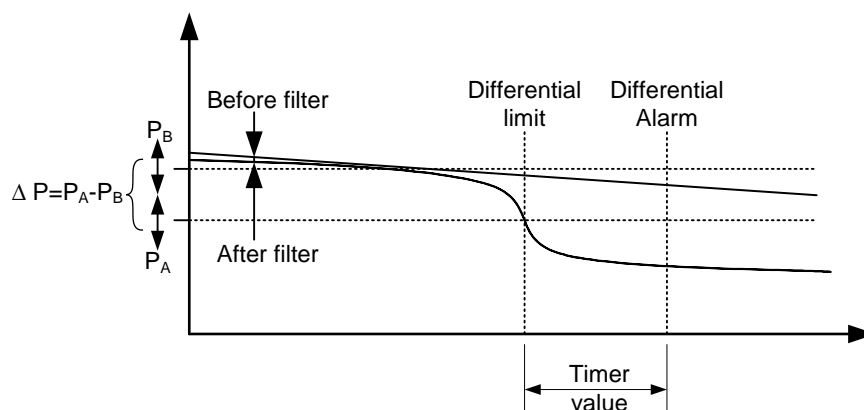

Six different differential measurements between two analogue input values can be configured, dependent on the unit options.

The analogue inputs can be selected from the list below.

M4	Analogue 102
	Analogue 105
	Analogue 108
H5/H7	EIC Oil pressure EIC Water temperature EIC Oil temperature EIC Ambient temperature EIC Intercooler temperature EIC Fuel temperature EIC Fuel delivery pressure EIC Air filter 1 diff. pressure EIC Air filter 2 diff. pressure EIC Fuel pump pressure EIC Filter diff. pressure EIC Oil filter diff. pressure EIC Crankcase pressure
H8.x	EXT Ana. In 1
	EXT Ana. In 2
	EXT Ana. In 3
	EXT Ana. In 4
	EXT Ana. In 5
	EXT Ana. In 6
	EXT Ana. In 7
	EXT Ana. In 8
M15.6	Analogue 91
	Analogue 93
	Analogue 95
	Analogue 97
M15.8	Analogue 127
	Analogue 129
	Analogue 131
	Analogue 133

The configuration is done in menus 4600-4606 and 4670-4676.

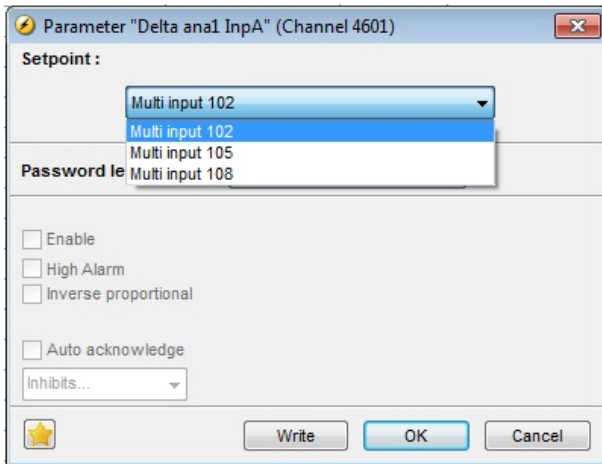

Each alarm can be configured in two alarm levels for each differential measurement between the analogue inputs A and B as follows. The configurations are done in menus 4610-4650 and 4680-4730.

Ain	4601	Delta ana1 InpA	1482	4
Ain	4602	Delta ana1 InpB	1483	4
Ain	4603	Delta ana2 InpA	1484	4
Ain	4604	Delta ana2 InpB	1485	4
Ain	4605	Delta ana3 InpA	1486	4
Ain	4606	Delta ana3 InpB	1487	4
Ain	4610	D input for B for analogue delta (A-B) alarm 3	1488	10
Ain	4620	Delta ana1 2	1489	10
Ain	4630	Delta ana2 1	1490	10
Ain	4640	Delta ana2 2	1491	10
Ain	4650	Delta ana3 1	1492	10
Ain	4660	Delta ana3 2	1493	10
Ain	4671	Delta ana4 InpA	1678	4
Ain	4672	Delta ana4 InpB	1679	4
Ain	4673	Delta ana5 InpA	1680	4
Ain	4674	Delta ana5 InpB	1681	4
Ain	4675	Delta ana6 InpA	1682	4
Ain	4676	Delta ana6 InpB	1683	4
Ain	4680	Delta ana4 1	1684	10
Ain	4690	Delta ana4 2	1685	10
Ain	4700	Delta ana5 1	1686	10
Ain	4710	Delta ana5 2	1687	10
Ain	4720	Delta ana6 1	1688	10
Ain	4730	Delta ana6 2	1689	10

The configurations are done in menus 4610-4650 and 4680-4730.

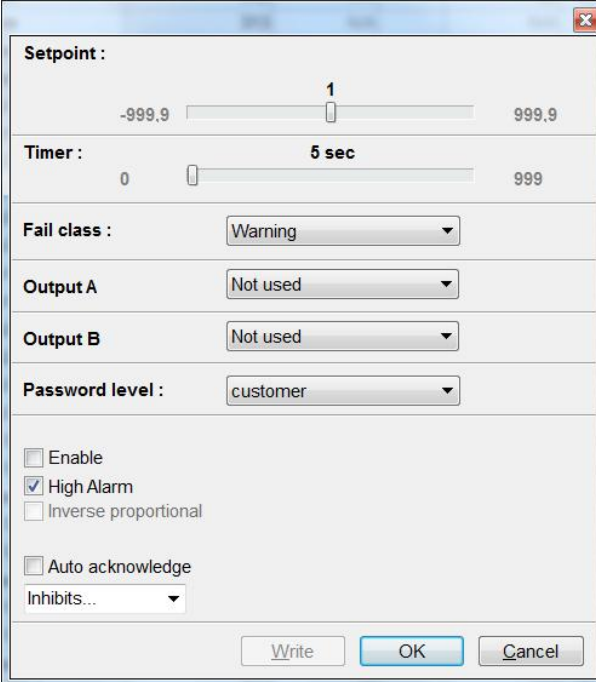

The screenshot shows a configuration window with the following fields and options:

- Setpoint :** A slider control with a value of 1, ranging from -999.9 to 999.9.
- Timer :** A slider control with a value of 5 sec, ranging from 0 to 999.
- Fail class :** A dropdown menu set to "Warning".
- Output A :** A dropdown menu set to "Not used".
- Output B :** A dropdown menu set to "Not used".
- Password level :** A dropdown menu set to "customer".
- Enable
- High Alarm
- Inverse proportional
- Auto acknowledge
- Inhibits...** dropdown menu

Buttons at the bottom: Write, OK, Cancel.

4.5 Digital inputs

The unit has a number of digital inputs. These inputs can be configured as inputs with dedicated logic functions, or they can be configured as alarm inputs.

Input functions

The table below illustrates all the input functions available in the GPC-3 and shows in which operation mode the described function will be active.

X = function can be activated.

	Input function	Remote	Local	Man	SWBD	Input type	Note
1	Access lock	X	X	X	X	Constant	
2	Start sync./control	X				Constant	
3	De-load	X				Constant	
4	Local mode	X				Pulse	
5	Remote mode		X			Pulse	
6	SWBD control	X	X	X		Constant	
7	Manual mode	X	X			Constant	
8	Alarm inhibit 1	X	X	X	X	Constant	
9	Remote GB ON	X				Pulse	
10	Remote GB OFF	X				Pulse	
11	Remote alarm ack.	X	X	X	X	Pulse	
12	Ext. communication control	X				Constant	
13	Reset analogue GOV/AVR outputs	X	X	X		Pulse	
14	Manual GOV up			X		Constant	
15	Manual GOV down			X		Constant	
16	Manual AVR up			X		Constant	Option D1
17	Manual AVR down			X		Constant	
18	Island mode	X	X			Constant	
19	Fixed frequency	X	X			Constant	
20	P load sharing	X	X			Constant	
21	Fixed P	X	X			Constant	
22	Frequency droop	X	X			Constant	
23	Ext. GOV set point	X	X			Constant	
24	Fixed voltage	X	X			Constant	Option D1
25	Q load sharing	X	X			Constant	
26	Fixed PF	X	X			Constant	
27	Fixed Q	X	X			Constant	
28	Voltage droop	X	X			Constant	
29	Ext. AVR set point	X	X			Constant	
30	Enable GB black close	X	X	X		Constant	
31	Enable sep. sync.	X	X	X		Constant	
32	GB spring loaded	X	X	X		Constant	
33	Digital running feedback	X	X	X	X	Constant	Option M4
34	Shutdown override	X	X	X	X	Constant	
35	Low speed	X	X			Constant	
36	Battery test	X	X			Constant	
37	Start enable	X	X	X		Constant	

	Input function	Remote	Local	Man	SWBD	Input type	Note
38	Remove starter	X	X	X		Constant	
39	Remote start	X	X			Pulse	
40	Remote stop	X	X			Pulse	
41	Remote start and close GB	X	X	X		Pulse	
42	Remote open GB and stop	X	X	X		Pulse	
43	GB close inhibit	X	X	X		Constant	Option G9
44	Force analogue LS	X	X			Constant	
45	BTB A pos. feedback ON	X	X	X	X	Constant	
46	BTB A pos. feedback OFF	X	X	X	X	Constant	
47	BTB B pos. feedback ON	X	X	X	X	Constant	
48	BTB B pos. feedback OFF	X	X	X	X	Constant	
49	BTB C pos. feedback ON	X	X	X	X	Constant	
50	BTB C pos. feedback OFF	X	X	X	X	Constant	
51	BTB D pos. feedback ON	X	X	X	X	Constant	
52	BTB D pos. feedback OFF	X	X	X	X	Constant	

4.5.1 Functional description

1. Access lock

Activating the access lock input deactivates the control display push-buttons. It will only be possible to view measurements, alarms and the log.

2. Start sync./control

The input starts the regulation and the control of the GOV(/AVR) is performed by the GPC. If the CB is open, then synchronising will start, and if the CB is closed, then the selected method of regulation will depend on the mode input selection.



When the GB is closed and the input is OFF, the GPC is in manual control mode and the display shows “MANUAL”.



To activate this command from M-Logic or external communication (for example Modbus), the M-Logic command “Start sync./ctrl enable” must be activated. Alternatively, you can use the functions “Remote GB ON” and “Remote GB OFF”.

3. De-load

The input starts the de-load function of the GPC. This will either be “Open breaker”, “De-load and open breaker” or “Prevent synchronising”.



This function only works together with “Start sync./control”.

4. Local

Changes the present running mode to local.

5. Remote

Changes the present running mode to remote.

6. SWBD control

Activates switchboard control, that is all controls and commands will stop. Protections are still active.

7. Manual

Changes the present running mode to manual.

8. Alarm inhibit 1

Specific alarms are inhibited to prevent the alarms from occurring.



Essential protections might also be inhibited, if inhibit is used.

9. Remote GB ON

The generator breaker ON sequence will be initiated and the breaker will synchronise if the busbar voltage is present, or close without synchronising if the busbar voltage is not present.

10. Remote GB OFF

The generator breaker OFF sequence will be initiated. In fixed frequency mode, the generator breaker will open instantly. In any other mode, the generator load will be de-loaded to the breaker open limit followed by a breaker open command.

11. Remote alarm acknowledge

Acknowledges all present alarms, and the alarm LED on the display stops flashing.

12. Ext. communication control

When the input is activated, the GPC is controlled from Modbus or Profibus only.



When load sharing mode is selected through the communication, the analogue load sharing lines are used.

13. Reset analogue GOV/AVR outputs

The analogue +/-20 mA controller outputs will be reset to 0 mA.



All analogue controller outputs are reset. That is the governor output and the AVR output if option D1 is selected.



If an offset has been adjusted in the control setup, then the reset position will be the specific adjustment.

14. Manual GOV up

If manual mode is selected, then the governor output will be increased.

15. Manual GOV down

If manual mode is selected, then the governor output will be decreased.

16. Manual AVR up

If manual mode is selected, then the AVR output will be increased.

17. Manual AVR down

If manual mode is selected, then the AVR output will be decreased.



The manual governor and AVR increase and decrease inputs can only be used in manual mode.

18. Island mode

This input deactivates the busbar measurements during breaker operations. This makes it possible to close the breaker from the GPC even though the generator and busbar are not synchronised.



The GPC will issue the close breaker signal even though the generator and busbar are NOT synchronised.



If this function is used, additional breakers must be installed between the generator and the point from which the busbar measurements are taken for the GPC. Otherwise the generator will close its circuit breaker without synchronism with subsequent damage, injury or death!



Serious personal injury, death and damaged equipment could be the result of using this input without proper safety precautions/testing prior to use. Take precautions that a high degree of safety is implemented in the application before using this function.



The function of the application must be checked and tested carefully during the commissioning when the island mode input is used. This is to ensure that no false breaker closings occur.

19. Fixed frequency

Input for selection of fixed frequency.

20. P load sharing

Input for selection of load sharing of the active power.

21. Fixed P

Input for selection of fixed active power.

22. Frequency droop

Input for selection of frequency droop.

23. Ext. GOV set point

Input for selection of external set point for the selected governor regulation mode.

24. Fixed voltage

Input for selection of fixed voltage.

25. Q load sharing

Input for selection of load sharing of the reactive power.

26. Fixed PF

Input for selection of fixed power factor.

27. Fixed Q

Input for selection of fixed reactive power.

28. Voltage droop

Input for selection of frequency droop.

29. Ext. AVR set point

Input for selection of external set point for the selected AVR regulation mode.

30. Enable GB black close

When the input is activated, the unit is allowed to close the generator on a dead busbar, providing that the frequency and voltage are inside the limits set up in menu 2110.

31. Enable separate sync.

Activating this input will split the breaker close and breaker synchronisation functions into two different relays. The breaker close function will remain on the relays dedicated for breaker control. The synchronisation function will be moved to a configurable relay dependent on the options configuration.

32. GB spring loaded

The unit will not send a close signal before this feedback is present.

33. Running feedback

The input is used as a running indication of the engine. When the input is activated, the start relay is deactivated.

34. Shutdown override

This input deactivates all protections except the overspeed protection and the emergency stop input. The number of start attempts is seven by default, but it can be configured in menu 6201. Also a special cool down timer is used in the stop sequence after an activation of this input.



The genset will not shut down in case of serious alarms that would shut down the genset during normal operation.

35. Low speed

Disables the regulators and keeps the genset running at a low RPM.



The governor must be prepared for this function.

36. Battery test

Activates the starter without starting the genset. If the battery is weak, the test will cause the battery voltage to drop more than acceptable, and an alarm will occur

37. Start enable

The input must be activated to be able to start the engine.



When the genset is started, the input can be removed.

38. Remove starter

The start sequence is deactivated. This means the start relay deactivates, and the starter motor will disengage.

39. Remote start

This input initiates the start sequence of the genset when remote mode is selected.

40. Remote stop

This input initiates the stop sequence of the genset when remote mode is selected. The genset will stop without cooling down.

41. Remote start and close GB

Pulse command to initiate the start sequence followed by synchronisation of the breaker.

42. Remote open GB and stop

Pulse command to initiate the GB OFF sequence (de-load + open) followed by the stop sequence (cooling down + stop).

43. GB close inhibit

When this input is activated, the GB ON sequence will not be initiated.

44. Force analogue LS

Used to force the analogue load sharing line active in a CANshare application.



Refer to the document “Description of options - Option G9” for a detailed description.

45-52. BTB A – BTB D pos. feedback

BTB feedbacks for BTB position supervision and control of LS sections in a CANshare application.



Refer to the document “Description of options - Option G9” for a detailed description.

Configuration

The digital inputs are configured via the PC utility software.

Select the input icon in the horizontal toolbar.

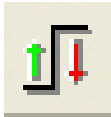

The desired input number can now be selected for the individual input function via the roll-down panel.



4.6 Multi-inputs

The GPC unit has three multi-inputs which can be configured to be used as the following input types:

1. 4 to 20 mA
2. 0 to 40 V DC
3. Pt100
4. Pt1000
5. RMI oil
6. RMI water
7. RMI fuel
8. Digital



The function of the multi-inputs can only be configured in the PC utility software.

Two alarm levels are available for each input, the menu numbers of the alarm settings for each multi-input are controlled by the configured input type as seen in the following table.

Input type	Multi-input 102	Multi-input 105	Multi-input 108
4 to 20 mA	4120/4130	4250/4260	4380/4390
0 to 40 V DC	4140/4150	4270/4280	4400/4410
Pt100/Pt1000	4160/4170	4290/4300	4420/4430
RMI oil	4180/4190	4310/4320	4440/4450
RMI water	4200/4210	4330/4340	4460/4470
RMI fuel	4220/4230	4350/4360	4480/4490
Digital	3400	3410	3420



Only one alarm level is available for the digital input type.

4.6.1 4 to 20 mA

If one of the multi-inputs has been configured as 4 to 20 mA, the unit and range of the measured value corresponding to 4 to 20 mA can be changed in the PC utility software in order to get the correct reading in the display.

4.6.2 0 to 40 V DC

The 0 to 40 V DC input has primarily been designed to handle the battery asymmetry test.

4.6.3 Pt100/1000

This input type can be used for heat sensor, for example cooling water temp. The unit of the measured value can be changed from Celsius to Fahrenheit in the PC utility software in order to get the desired reading in the display.

4.6.4 RMI inputs

The unit can contain up to three RMI inputs. The inputs have different functions, as the hardware design allows for several RMI types.

These various types of RMI inputs are available for all multi-inputs:

RMI oil:	Oil pressure
RMI water:	Cooling water temperature
RMI fuel:	Fuel level sensor

For each type of RMI input it is possible to select between different characteristics including a configurable.

4.6.5 RMI oil

This RMI input is used to measure the lubricating oil pressure.

		RMI sensor type		
Pressure		Type 1	Type 2	Type 3
Bar	psi	Ω	Ω	Ω
0	0	10.0	10.0	Type 3 is not available when RMI oil is selected
0.5	7	27.2		
1.0	15	44.9	31.3	
1.5	22	62.9		
2.0	29	81.0	51.5	
2.5	36	99.2		
3.0	44	117.1	71.0	
3.5	51	134.7		
4.0	58	151.9	89.6	
4.5	65	168.3		
5.0	73	184.0	107.3	
6.0	87		124.3	
7.0	102		140.4	
8.0	116		155.7	
9.0	131		170.2	
10.0	145		184.0	

 The configurable type is configurable with eight points in the range 0 to 480 Ω . The resistance as well as the pressure can be adjusted.

 If the RMI input is used as a level switch, then be aware that voltage must not be connected to the input. If any voltage is applied to the RMI input, it will be damaged. Refer to the Application Notes for further wiring information.

4.6.6 RMI water

This RMI input is used to measure the cooling water temperature.

		RMI sensor type			
Temperature		Type 1	Type 2	Type 3	Type 4
°C	°F	Ω	Ω	Ω	Ω
40	104	291.5	480.7	69.3	Type 4 is not available when RMI water is selected
50	122	197.3	323.6		
60	140	134.0	222.5	36.0	
70	158	97.1	157.1		
80	176	70.1	113.2	19.8	
90	194	51.2	83.2		
100	212	38.5	62.4	11.7	
110	230	29.1	47.6		
120	248	22.4	36.8	7.4	
130	266		28.9		
140	284		22.8		
150	302		18.2		

 The configurable type is configurable with eight points in the range 0 to 480 Ω. The temperature as well as the resistance can be adjusted.

 If the RMI input is used as a level switch, then be aware that voltage must not be connected to the input. If any voltage is applied to the RMI input, it will be damaged. Refer to the Application Notes for further wiring information.

4.6.7 RMI fuel

This RMI input is used for the fuel level sensor.

		RMI sensor type
		Type 1
Value		Resistance
0 %		78.8 Ω
100 %		1.6 Ω

		RMI sensor type
		Type 2
Value		Resistance
0 %		3 Ω
100 %		180 Ω

 If the RMI input is used as a level switch, then be aware that voltage must not be connected to the input. If any voltage is applied to the RMI input, it will be damaged. Refer to the Application Notes for further wiring information.

	RMI sensor type
Value	Type configurable
%	Resistance
0	
10	
20	
30	
40	
50	
60	
70	
80	
90	
100	

 The configurable type is configurable with eight points in the range 0 to 480 Ω. The value as well as the resistance can be adjusted.

4.6.8 Illustration of configurable inputs

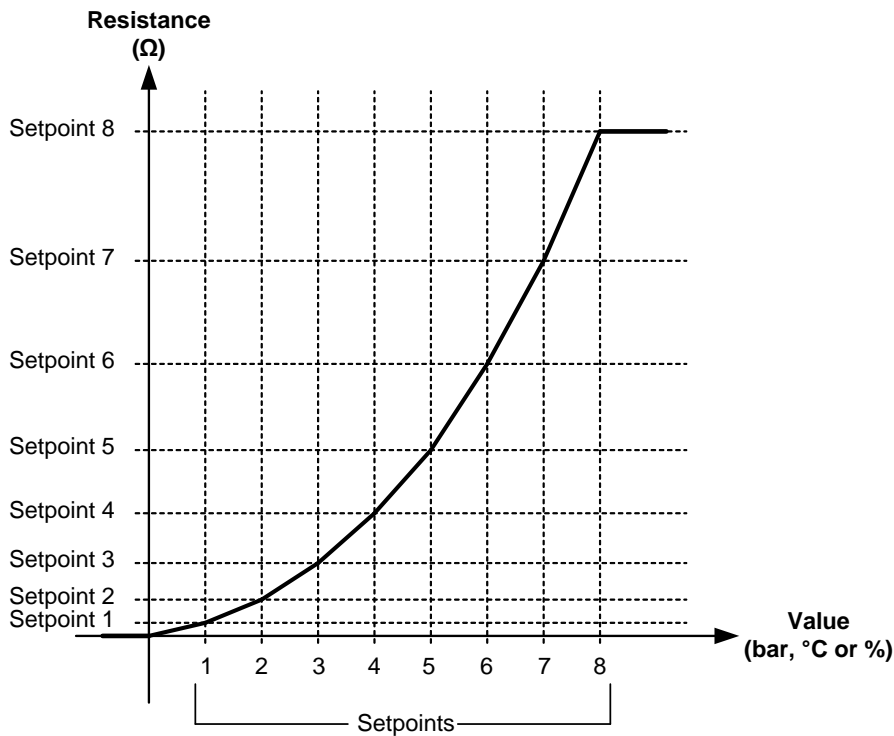

4.6.9 Configuration

The eight curve settings for the configurable RMI inputs cannot be changed in the display, but **only** in the PC utility software. The alarm settings can be changed both in the display and in the PC utility software. In the PC utility software, the configurable inputs are adjusted in this dialogue box:

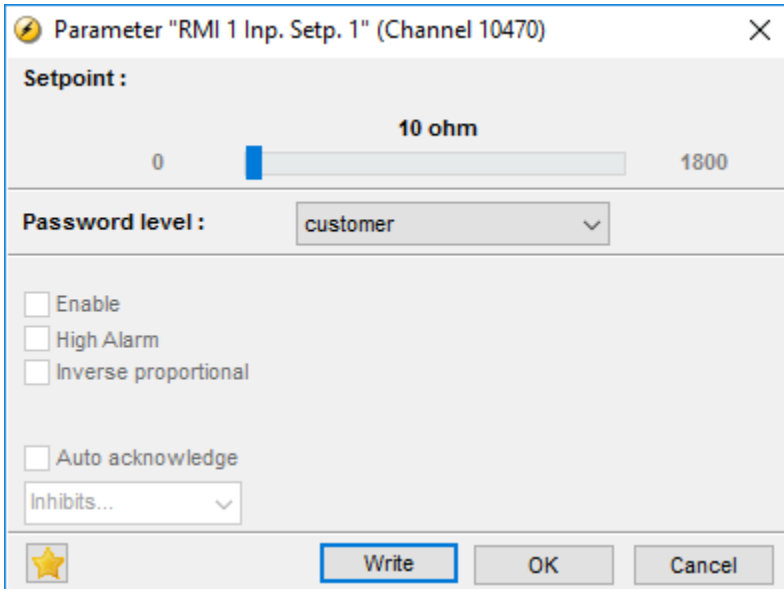

The screenshot shows a configuration window titled "Parameter 'RMI 1 Inp. Setp. 1' (Channel 10470)". It features a "Setpoint:" section with a slider ranging from 0 to 1800, currently set at 10 ohm. Below this is a "Password level:" dropdown menu set to "customer". There are four unchecked checkboxes: "Enable", "High Alarm", "Inverse proportional", and "Auto acknowledge". An "Inhibits..." dropdown menu is also present. At the bottom, there is a star icon, a "Write" button, and "OK" and "Cancel" buttons.

Adjust the resistance of the RMI sensor at the specific measuring value. In the example above, the adjustment is 10 Ω at 0.0 bar.

4.6.10 Scaling of 4 to 20 mA inputs

The scaling of the analogue inputs is made to ensure that the readout of the inputs is made with a resolution that fits the connected sensor. It is recommended to follow the list below when changing the scaling of the analogue inputs.

1. Set up the multi-input for 4 to 20 mA. This is done in menus 10980-11000 for multi-inputs 102-108 and in menus 11120-11190 for option M15 or M16.
2. Now the scaling parameters are available in menus 11010-11110.
3. Activate the AUTO SCALE enable checkbox when setting up the inputs. This means that the reading remains the same - but decimals are added.
4. Deactivating AUTO SCALE will make the reading smaller by a factor of 10 for each decimal added.
5. Then the alarm parameters for the multi-inputs can be configured.
6. A parameter file (usw file) should always be saved without the AUTO SCALE enabled.



The setup of the multi-inputs and alarm parameters must be done in the above order. If not, the alarm levels will be wrong.

Category	Channel	Text	Address	Value
Alr	4000	4-20mA 91.1	256	10
Alr	4010	4-20mA 91.2	257	10
Alr	4020	W. fal ana 91	264	N/A
Alr	4030	4-20mA 93.1	258	10
Alr	4040	4-20mA 93.2	259	10
Alr	4050	W. fal ana 93	265	N/A
Alr	4060	4-20mA 95.1	260	10
Alr	4070	4-20mA 95.2	261	10
Alr	4080	W. fal ana 95	266	N/A
Alr	4090	4-20mA 97.1	262	10
Alr	4100	4-20mA 97.2	263	10
Alr	4110	W. fal ana 97	267	N/A

Setting up decimals:

No decimals:

0 to 5 bar oil pressure transducer (4 to 20 mA)
Decimals = 0

Without use of decimals, the set point can only be adjusted in steps of one bar, which gives a very rough range of setting.

```

Analog 127      4mA
Analog 129      4mA
Analog 131      4mA
SETUP  V3  V2  V1  P01
    
```

The display will show 0 to 5 bar in the measuring range 4 to 20 mA.

One decimal:

0 to 5 bar oil pressure transducer (4 to 20 mA)
Decimals = 1
Auto scale = enable

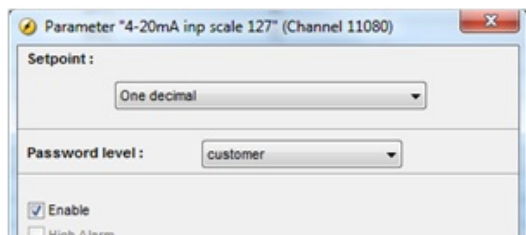

```

Analog 127      4.0mA
Analog 129      4mA
Analog 131      4mA
SETUP  V3  V2  V1  P01
    
```

Decimals = 1, AUTO SCALE = enabled

```

Analog 127      0.4mA
Analog 129      4mA
Analog 131      4mA
SETUP V3 V2 V1 P01
    
```

Decimals = 1, AUTO SCALE = disabled

i **Regarding AUTO SCALE:** if the number of decimals is changed without enabling the set point, the 4 to 20 mA will be presented as 0.4 to 2.0 mA (0.0 to 0.5 bar). In other words, the "Auto scaling" bit decides where the decimal point is placed.

Setting up the measuring range of the sensor:

The measuring range of the multi-input is set up inside the actual alarm:

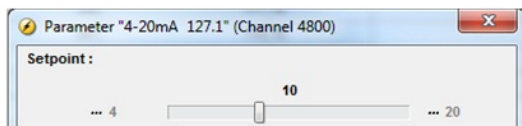

The three dots to the left of the figures is a button. Scale the input as required, for example 0 to 5 bar:

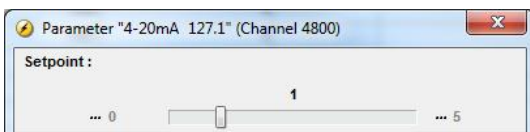

The display will then show 0 at 4 mA.

In order to get the alarm input to work again after changing the "decimal setting", it is necessary to make a readjustment of the alarm:

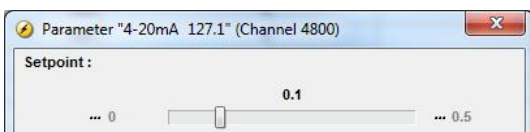

Change it to match the new selection of decimals.

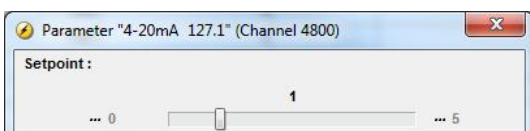

Therefore, when selecting decimals, the selection of AUTO SCALE depends on whether the alarm inputs are already set up. If they are set up, it is a good idea to select AUTO SCALE. If they are not set up, it is voluntary if AUTO SCALE is selected.

Reload parameters:

It is necessary to upload the parameters from the device to the computer after changing the scale (no decimal/one decimal/two decimal) settings. This is in order to refresh the parameter list so the alarm settings present the correct value:

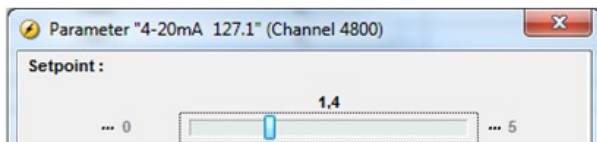

In the example shown above, the value can be adjusted with one decimal. If the parameters were not refreshed, it would still only be possible to adjust the set point without decimals.

Save the parameter file:

A parameter file (usw file) should always be saved without the AUTO SCALE enabled.

After having set up the 4 to 20 mA inputs (HW as well as alarms), the parameter file should be uploaded from the device to the PC and then saved. In this way, the AUTO SCALE is deactivated (automatically cleared by the device), and the settings will not be modified again if the parameters are reloaded to the device.

If the file is saved with the AUTO SCALE enabled, the minimum and maximum values of the alarm will be affected (multiplied by 10 or 100) at the next use of the parameter file (under certain conditions).

4.6.11 Digital

If the multi-inputs are configured to "Digital", they become available as a configurable input.

4.7 Event log

4.7.1 Logs

The event logging of data is divided into three different groups:

- Event log containing 150 loggings
- Alarm log containing 30 loggings
- Battery test log containing 52 loggings

The logs can be viewed in the display or in the PC utility software. When the individual logs are full, each new event will overwrite the oldest event following the "first in – first out" principle.

Display

In the display it looks like this when the "LOG" push-button is pressed:



Now it is possible to select one of the three logs.

If "Event" is selected, the log could look like this:

G	400	400	400V
4170 Fuel level			
06-24	15:24:10.3		
INFO	<u>FIRST</u>	LAST	



The specific alarm or event is shown in the second line. In the example above the fuel level alarm has occurred. The third line shows the time stamp.

If the cursor is moved to "INFO", the actual value can be read when pressing "SEL" :

G	400	400	400V
4170 Fuel level			
VALUE	8%		
<u>INFO</u>	FIRST	LAST	

The first event in the list will be displayed, if the cursor is placed below "FIRST" and "SEL" is pressed.

The last event in the list will be displayed, if the cursor is placed below "LAST" and "SEL" is pressed.

The  and  push-buttons are used to navigate in the list.

PC utility software

Using the PC utility software, the entire log stack of the last 150 events can be retrieved by activating the log button on the horizontal toolbar.



The alarms and events are displayed as indicated below. The actual alarms are displayed in the text column together with selected measurements.

In the right side column, additional data is indicated. This is specific data for the most important measurements. The data is logged for each specific event and is used for troubleshooting after each alarm.

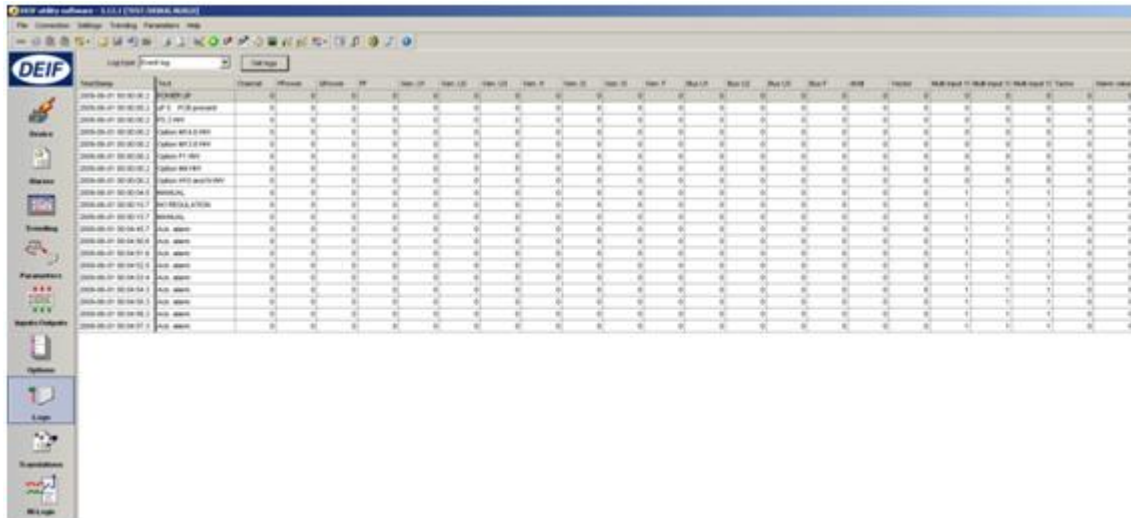

i The entire log can be saved in Excel format and used in that particular programme.

4.8 External set points

4.8.1 External analogue set point

The genset can be controlled from internal as well as from external set points. The external set point is activated with a digital signal, “Ext. GOV set point”, but the set point itself is analogue.

The table below shows the possible set points.

Mode	Input voltage	Description
Fixed frequency	+/-10 V DC	fNOM +/-5 Hz
Fixed power	+/-10 V DC	0 % to 100 % *PNOM
Frequency droop	+/-10 V DC	fNOM +/-5 Hz
Load sharing	+/-10 V DC	fNOM +/-5 Hz

When the input “Ext. GOV set point” is activated, the set point immediately changes from internal set point to external set point and the regulation acts accordingly. This will give a sudden change in the governor control. If a more smooth change of the set point is required, the analogue input on the external set point must be changed stepwise.

i Refer to the manual “Description of option D1” for information regarding external AVR control.

i If option H2 is available in the unit, the external set points can be controlled from the control registers in the Modbus protocol. Refer to the manual “Description of option H2” for further information.

i Fixed power cannot go below 0 %, even if your lower limit is negative.

4.8.2 Scaling of analogue inputs for external set point control

Scaling of fixed power:

The scaling of the maximum and minimum allowed power is done in parameter 2841 "Max. P range" and 2842 "Min. P range". The scaling is done in percent of the nominal set point.

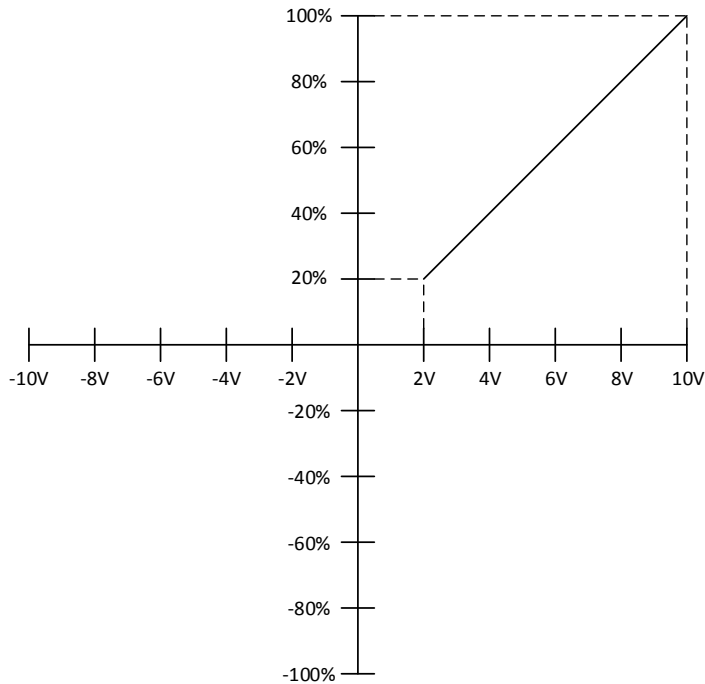

The scaling of the analogue input is done in parameter 2843 "Max. f/P" and 2844 "Min. f/P".

Parameter	Name	Setting
2841	Max. P range	100 %
2842	Min. P range	20 %
2843	Max. f/P	10 V
2844	Min. f/P	2 V

Scaling of fixed frequency:

The scaling of the analogue input is done in parameter 2843 "Max. f/P" and 2844 "Min. f/P". There is no scaling of frequency range, it will always be +/- 5 Hz of the nominal setting.

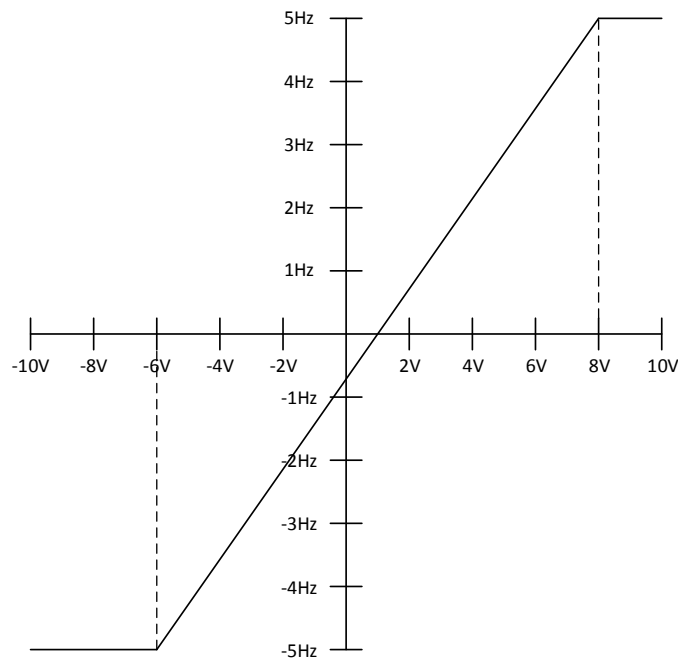

Parameter	Name	Setting
2843	Max. f/P	8 V
2844	Min. f/P	-6 V



Parameters 2843 “Max. f/P” and 2844 “Min. f/P” are shared between fixed frequency and fixed power because they both use the same analogue input.

Fixed var

The scaling of the analogue input is done in parameters 2845 “Max. U/Q” and 286 “Min. U/Q”. There is no scaling of var range, it will always be from 0 to 100 % of the nominal power set point.

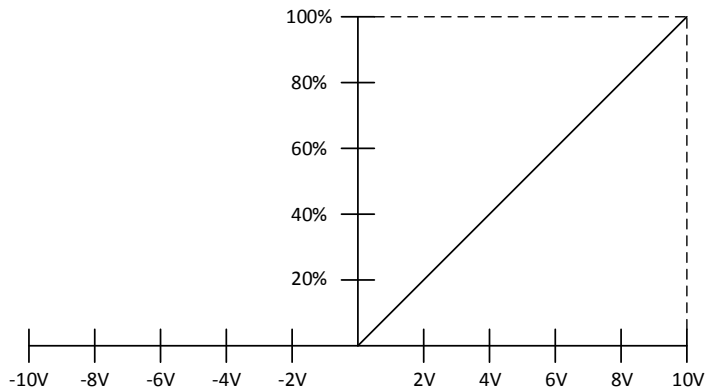

Parameter	Name	Setting
2845	Max. U/Q	10 V
2846	Min. U/Q	0 V

Fixed voltage

The scaling of the analogue input is done in parameters 2845 "Max. U/Q" and 286 "Min. U/Q". There is no scaling of voltage range, it will always be +/- 10 % of the nominal voltage setting.

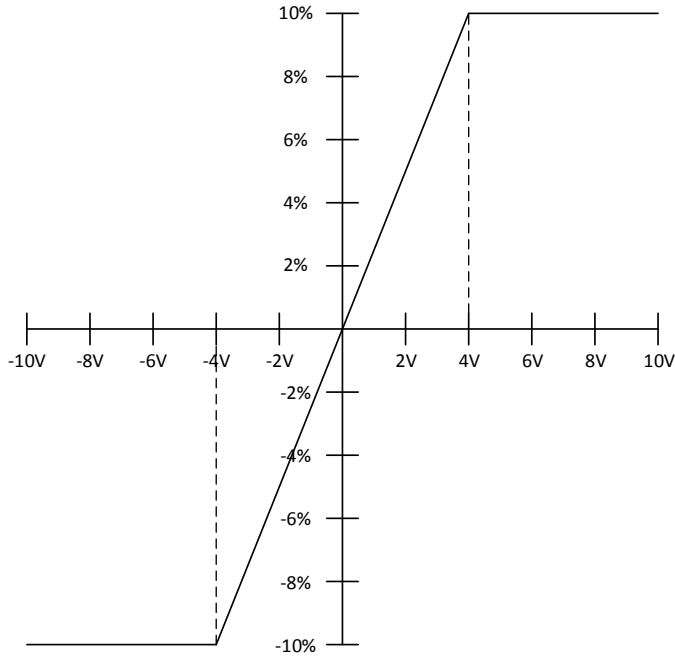

Parameter	Name	Setting
2845	Max. U/Q	4 V
2846	Min. U/Q	-4 V

i Parameters 2845 “Max. f/P” and 2846 “Min. f/P” are shared between fixed var and fixed voltage because they both use the same analogue input.

4.8.3 External set point selection

There are various principles for the GPC to control the genset through set point selection. These are internal or external set points or optional control via external communication.

i Set points via external communication is optional; Modbus (H2) or Profibus (H3).

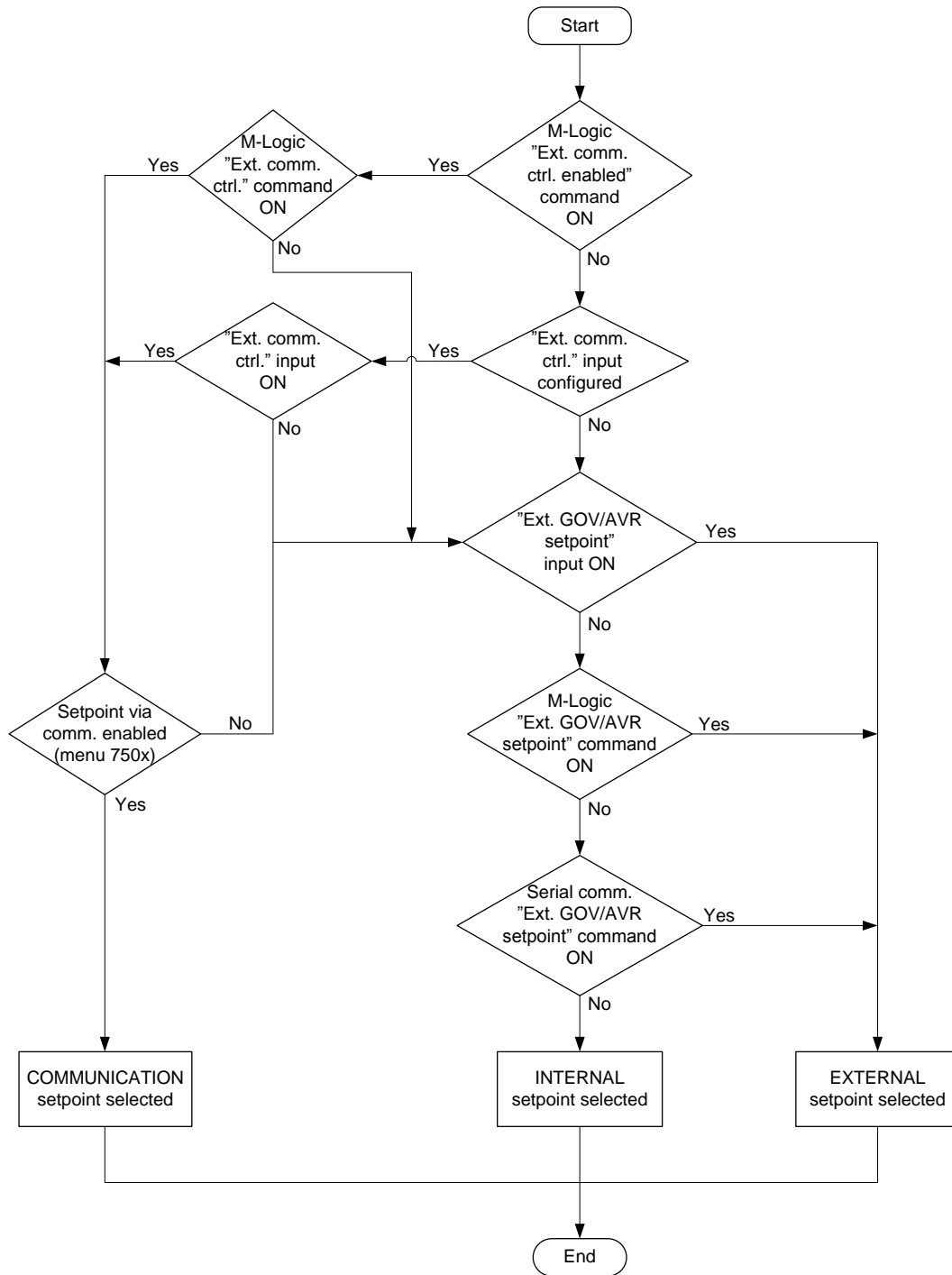

Set point selection	Description
Internal	Set point is taken from the internal settings, for example nominal frequency for fixed frequency
External	The set point is taken from the analogue inputs (+/-10 V DC)
Communication	Set points are taken from the control register

Control set points

The control set points are described in the table below.

Mode/Set point	Internal	External	Communication (Ctrl. reg. table)
Fixed frequency	Nom. frequency	+/-5 Hz	Address 3
Fixed power	Menu 7051	0 to 100 %	Address 1
Frequency droop	Menu 2514 or 2573	+/-5 Hz	Address 3
Load sharing	Analogue lines	+/-5 Hz	Analogue lines

4.9 Fail class

All activated alarms must be configured with a fail class. The fail classes define the category of the alarms and the subsequent alarm action.

Five different fail classes can be used. The tables below illustrate the action of each fail class when the engine is running or stopped.

Engine running

Fail class/Action	Alarm horn relay	Alarm display	De-load	Trip of GB	Cooling-down genset	Stop genset
1 Block	X	X				
2 Warning	X	X				
3 Trip of GB	X	X		X		
4 Trip and stop	X	X		X	X	X
5 Shutdown	X	X		X		X
6 Safety stop	X	X	X		X	X



Safety stop will not de-load the GB in Manual or SWBD mode. In this case, the fail class will have the same functionality as the "Block" fail class.

The table illustrates the action of the fail classes. If, for example, an alarm has been configured with the "shutdown" fail class, the following actions occur:

- The alarm horn relay will activate
- The alarm will be displayed in the alarm info screen
- The generator breaker will open instantly
- The genset is stopped instantly
- The genset cannot be started from the unit (see next table)

Engine stopped

Fail class/Action	Block engine start	Block GB sequence
1 Block	X	
2 Warning		
3 Trip GB	X	X
4 Trip and stop	X	X
5 Shutdown	X	X
6 Safety stop	X	X

 In addition to the actions defined by the fail classes, it is possible to activate one or two relay outputs, if additional relays are available in the unit.

4.9.1 Fail class configuration

The fail class can be selected for each alarm function either via the display or the PC software.

To change the fail class via the PC software, the alarm function to be configured must be selected. Select the desired fail class in the fail class drop-down panel.

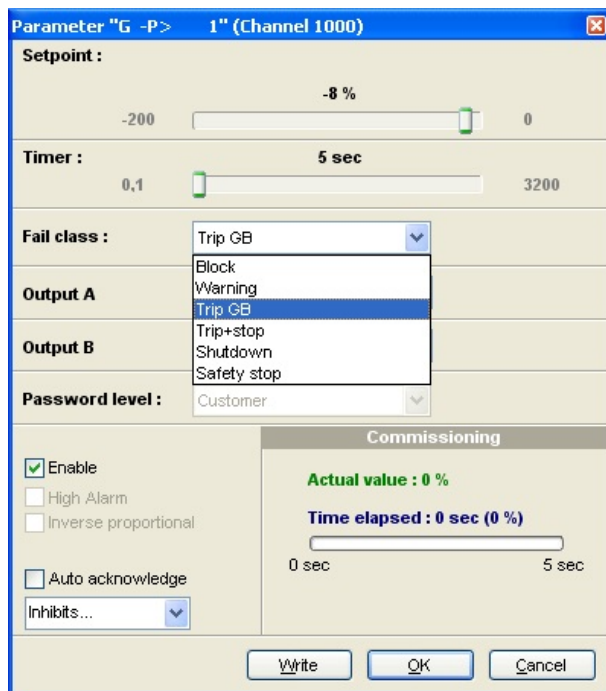

4.10 Frequency-dependent power droop

This droop function can be used when the genset is parallel to the mains. In case the frequency drops or rises due to instability of the mains, the curve for frequency-dependent droop is made to compensate the power set point.

Example:

With a nominal frequency of 50 Hz and an actual frequency of 51.5 Hz, there is a deviation of 1.5 Hz which is equal to a 3 % deviation from the nominal setting. The genset will then droop to 400 kW according to the vector diagram below.

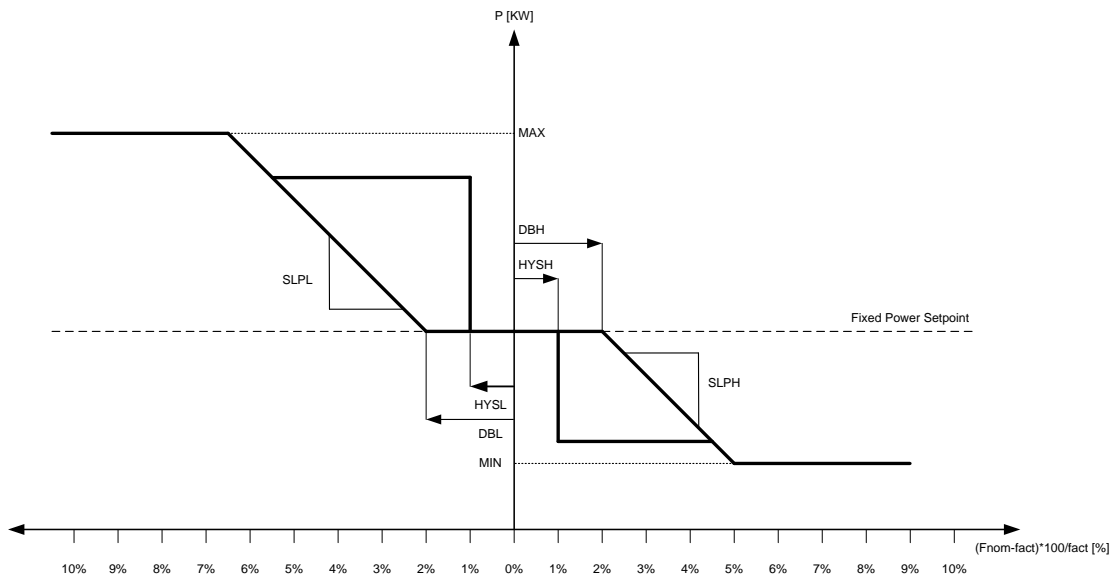

The vector diagram above is configured with the parameter settings as in the following table.

The curve can be designed inside MIN/MAX [kW] area.

Menu	Settings	Name	Description
7051	450	kW	Fixed power set point.
7121	2	DBL[%]	Deadband low in percentages of nominal frequency.
7122	2	DBH[%]	Deadband high in percentages of nominal frequency.
7123	1	HYSL[%]	Hysteresis low in percentages of nominal frequency. If HYSL is set above DBL, the hysteresis low is disabled.
7124	1	HYSH[%]	Hysteresis high in percentages of nominal frequency. If HYSH is set above DBH, the hysteresis high is disabled.
7131	150	MIN[kW]	Minimum output of droop handling.
7132	900	MAX[kW]	Maximum output of droop handling.
7133	50	SLPL[kW/%]	Slope low. The setting determines the increase/decrease of power reference per percentage the actual frequency drops below nominal frequency.
7134	-50	SLPH[kW/%]	Slope high. The setting determines the increase/decrease of power reference per percentage the actual frequency rises above nominal frequency.
7143	ON	Enable	Enable droop curve function.

This droop function is performed based on the actual value for the power set point in the moment the droop is activated. If for example, the function is activated during ramping and the actual power value at this moment is 200 kW, the droop is performed based on 200 kW as the "Fixed Power Set point" stated in the diagram.

The slopes (7133/7134) are used, as long as the mains frequency has a direction away from nominal settings. When the mains is starting to recover and the frequency is heading towards the nominal settings, the power set point is waiting to be restored until the frequency is within the hysteresis limits. If the hysteresis is disabled, the power set point will simply be restored using the slope.

When drooping, the slopes will be scaled based on size of the actual power at the droop start, compared to the specified nominal power. For example, if a DG of nominal 1000 kW is producing 500 kW when droop is activated, then only 50 % of the slope values will be used. To achieve a nominal droop of 40 % per Hz, a 1000 kW (50 Hz) DG should be configured with slopes of 200 kW/%. If the DG then only is producing 500 kW when droop is activated, the actual slope will be experienced as 100 kW/%.

If "Auto ramp selection" is enabled (channel 2624), the secondary pair of ramps will be used during frequency-dependent power droop. In order to prevent a new situation with faulty mains, it may be advantageous to use slower ramps in or after a situation with an unstable mains. The secondary ramps will automatically be disabled again when the frequency-dependent power droop is no longer active, and the specified power set point is reached. If "Auto ramp selection" is disabled, it is only possible to activate the secondary ramps using M-Logic. Parameters used for the secondary ramps are stated in the table below.

Menu	Default	Name	Description
2616	0.1[%/s]	Ramp up speed 2	Slope of ramp 2 when ramping up.
2623	0.1[%/s]	Ramp down speed 2	Slope of ramp 2 when ramping down (not used for de-load).
2624	ON	Auto ramp selection	Activate or deactivate automatic selection of secondary ramps.

 **The frequency-dependent droop is only available in fixed power mode.**

This function relates to settings 7051 and 7121-7143.

All configurable relays can be chosen to be a horn output. This means that the relay can be connected to an alarm annunciator, for example a horn. Every time a new alarm occurs, the horn output will activate.

The horn output will activate on all alarms. The output remains activated until:

- The alarm is acknowledged
- The horn relay timer runs out (automatic reset function)

 **When a relay is used as a horn relay, it cannot be used for other purposes.**

 **The horn output will not activate on limit switch functions.**

Automatic reset

The horn relay function has an automatic reset function. When the timer (menu 6130) differs from 0 seconds, the horn relay output resets itself when the delay has expired. This is also the situation when the alarm is STILL present.

 **The horn output resets when the alarm is still present. This is the function of the “Automatic reset”.**

Manual reset

If the time is set to 0.0 s, the automatic reset of the horn output is disabled. The horn will remain ON until the alarm is acknowledged by the operator. Now, the status of the alarm changes from unacknowledged (UN-ACK.) to acknowledged (ACK.).

 **If the alarm condition is gone when the alarm is acknowledged, then the specific alarm message also disappears.**

The controller has two transistor outputs, each representing a value for the power production. The outputs are pulse outputs, and the pulse length for each of the activations is 1 second.

Term. number	Output
20	kWh
21	kvarh
22	Common terminal

The number of pulses depends on the actual adjusted setting of the nominal power:

Generator power	Value	Number of pulses (kWh)	Number of pulses (kvarh)
P _{NOM}	<100 kW	1 pulse/kWh	1 pulse/kvarh
P _{NOM}	100 to 1000 kW	1 pulse/10 kWh	1 pulse/10 kvarh
P _{NOM}	>1000 kW	1 pulse/100 kWh	1 pulse/100 kvarh

 The kWh measurement is shown in the display as well, but the kvarh measurement is only available through the transistor output.

 Be careful - the maximum burden for the transistor outputs is 10 mA.

4.11 Language selection

4.11.1 Language selection

The unit can display different languages. It is delivered with one master language, which is English. This is the default language, and it cannot be changed. In addition to the master language, 11 different languages can be configured. This is done via the PC utility software “Translations” function.

The active language is selected in menu 6080. The language can be changed when connected to the PC utility software. It is not possible to make language configuration from the display, but already configured languages can be selected.

SETUP + 

```
GPC          V 3.00.0
2010-01-02   04:26:02
SETUP MENU
SETUP  V3  V2  V1
```

SYST + 





```
G  0  0  0V
G  f-L1  0.00Hz
PROTECTION SETUP
PROT  CTRL  I/O  SYST
```

GEN + 

```
G  0  0  0V
SYSTEM SETUP
GENERAL SETUP
GEN  MAINS  COMM
```

6080 + 

```
G  0  0  0V
6080 Language
English
LANG
```

LANG +  +  or  SAVE + 

```
G  0  0  0V
6081 Language
English
RESET          SAVE
```

4.12 Memory backup

4.12.1 Memory backup

When changing the internal battery for the memory, all settings will be lost. The memory backup feature gives the possibility to back up the controller settings, and after replacing the battery the settings can be restored.

DEIF recommends that a backup is made at least when the commissioning is tested and done. The following settings will be stored in the backup:

Type	Stored
Identifiers	X
Counters	X
Views configuration	X
Inputs configuration	X
Outputs configuration	X
Translations	
M-Logic configuration	X
AOP-1 configuration	X
AOP-2 configuration	X
Application configuration	X
Parameters	X
Modbus configuration	X
Permissions	X
Logs	



If new firmware is flashed to the controller, the backup will be erased.



The controller will reboot after a backup has been restored.

The backup is found in parameter **9230 Memory backup** with the jump menu. In this parameter you are able to backup or restore.

Internal battery alarm

If the internal battery is dismantled during operation, a failure will appear on the display.

4.13 Load sharing

4.13.1 Load sharing

The analogue load sharing line enables the unit to share the active load equally in percentage of the nominal power. The analogue load sharing is active when the genset is running in P load sharing mode and the generator breaker is closed.

A voltage signal equal to the load produced by the genset is sent to the load sharing line. When the generator load is 0 %, 0 V DC is sent to the load sharing line. When the load is 100 %, the voltage will be 4 V DC.

This is illustrated in the drawing below.

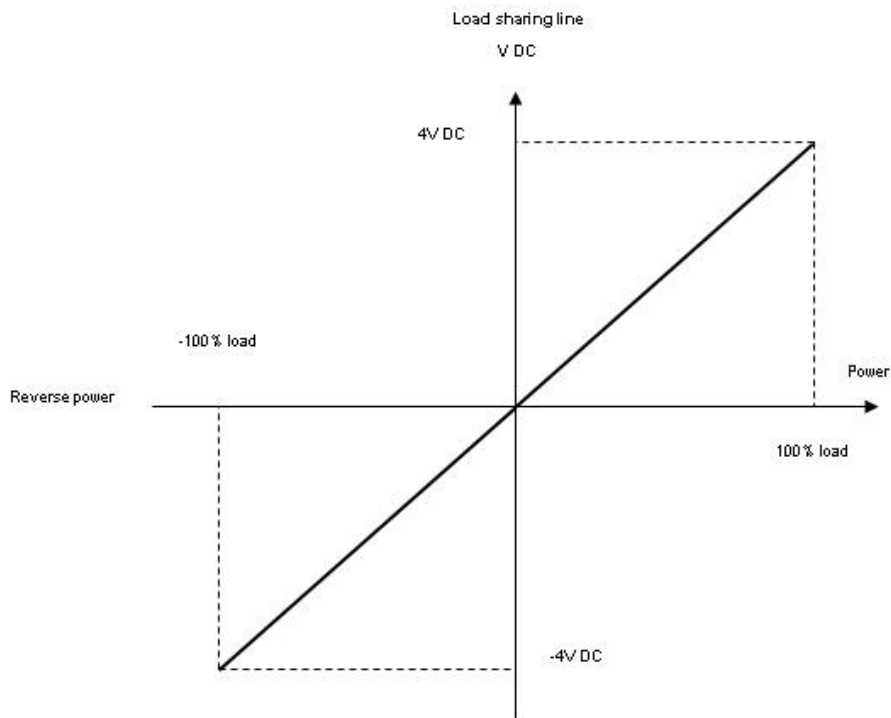

The characteristics of the reactive load sharing line are equivalent.

Principle

The GPC-3 supplies a voltage on the load sharing line equal to the actual load. This voltage comes from an internal power transducer in the GPC-3. At the same time, the actual voltage on the load sharing line will be measured by the GPC-3.

- If the measured voltage is higher than the voltage from the internal power transducer, then the GPC-3 will increase its load in order to match the voltage on the load sharing line.
- If the measured voltage is lower than the voltage from the internal power transducer, then the GPC-3 will decrease its load in order to match the voltage on the load sharing line.

The voltage on the load sharing line will only be different from the voltage from the internal power transducer if two or more Multi-line 2 units are connected to the load sharing line. For the same reason, it is not necessary to change between load sharing mode and fixed frequency mode if the GPC-3 is installed in an island mode application where the operation changes between stand-alone and load sharing mode. Then the mode inputs can be hardwired.

Examples

These examples show that generators will balance their load depending on the signal on the load sharing line.

Example 1:

Two generators are running in parallel. The loads of the generators are:

Generator	Actual load	Voltage on load sharing line
Generator 1	100 %	4 V DC
Generator 2	0 %	0 V DC

The voltage level on the load sharing line can be calculated to:

$$\text{ULS: } (4 + 0)/2 = 2 \text{ V DC}$$

Now generator 1 will decrease the load in order to match the voltage on the load sharing line (in this example 2 V DC). Generator 2 will increase the load in order to match the 2 V DC.

The new load share situation will be:

Generator	Actual load	Voltage on load sharing line
Generator 1	50 %	2 V DC
Generator 2	50 %	2 V DC

Example 2:

In case of generators of different sizes, the load sharing will still be carried out on the basis of a percentage of the nominal power.

Two generators supply the busbar. The total load is 550 kW.

Generator	Nominal power	Actual load	Voltage on load sharing line
Generator 1	1000 kW	500 kW	2 V DC
Generator 2	100 kW	50 kW	2 V DC

Both generators are supplying 50 % of their nominal power.

Ramp up function

In the menu 2610, it is possible to enable a power ramp up function when operating in load sharing mode.

When this function is enabled, the GPC-3 will not balance the load immediately when the breaker is closed, but will follow the adjusted power ramp up curve (menu 2141). This means that the other generator(s) will carry the majority of the load during the time where the actual generator is in its ramp up sequence.

The power set point is still reflecting the reference on the load sharing line (0 to 4 V DC ~ 0 to 100 %). When the generator has reached the set point, it follows the load without further ramp functions.

The ramp function is initiated when P load sharing mode is selected and the GB closes.



If the ramp up delay point (menu 2613) is used, the actual power production during the delay period will not match the adjusted value exactly. This is because the regulator set point is a mix between the power and frequency controllers when operating in load sharing mode.

Load sharing/NO RAMP

This diagram shows how the load balances after breaker closing when the ramp function (in load sharing mode) is deactivated. The load is balanced immediately, followed by load sharing between the two DGs.

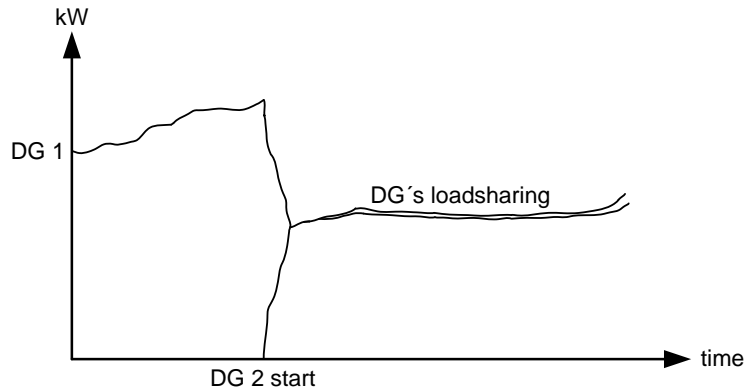

Load sharing/RAMP UP FUNCTION

This diagram shows a situation after the breaker closes and where the ramp function is activated. When DG 2 synchronises, it loads up following the ramp curve. Any variations in load will in principle be taken by DG 1, until the ramp sequence has ended.

In this diagram, no delay point is used (timer 2143 = 0 s).

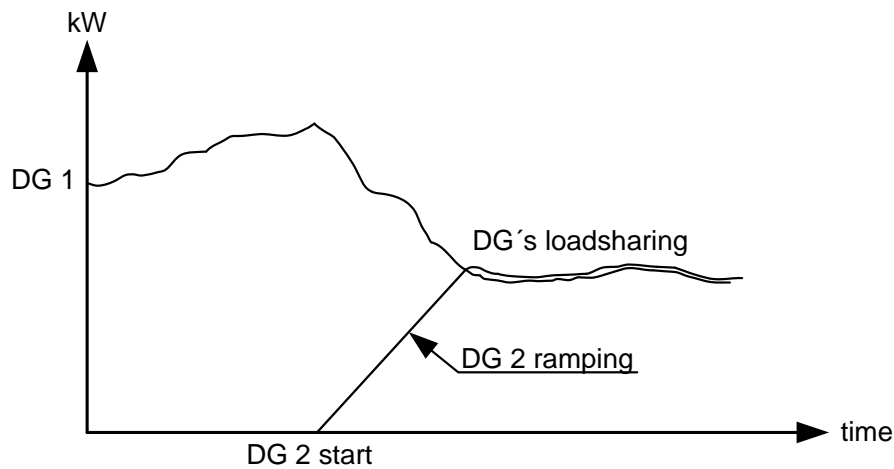

Ramp up with load steps

When the GB is closed, the power set point continues to rise in ramp up steps, the number of steps in menu 2615. If the delay point is set to 20 % and the number of load steps is set to 3, the genset will ramp to 20 %, wait the configured delay time, ramp to 40 %, wait, ramp to 60 %, wait and then ramp to the present power set point.

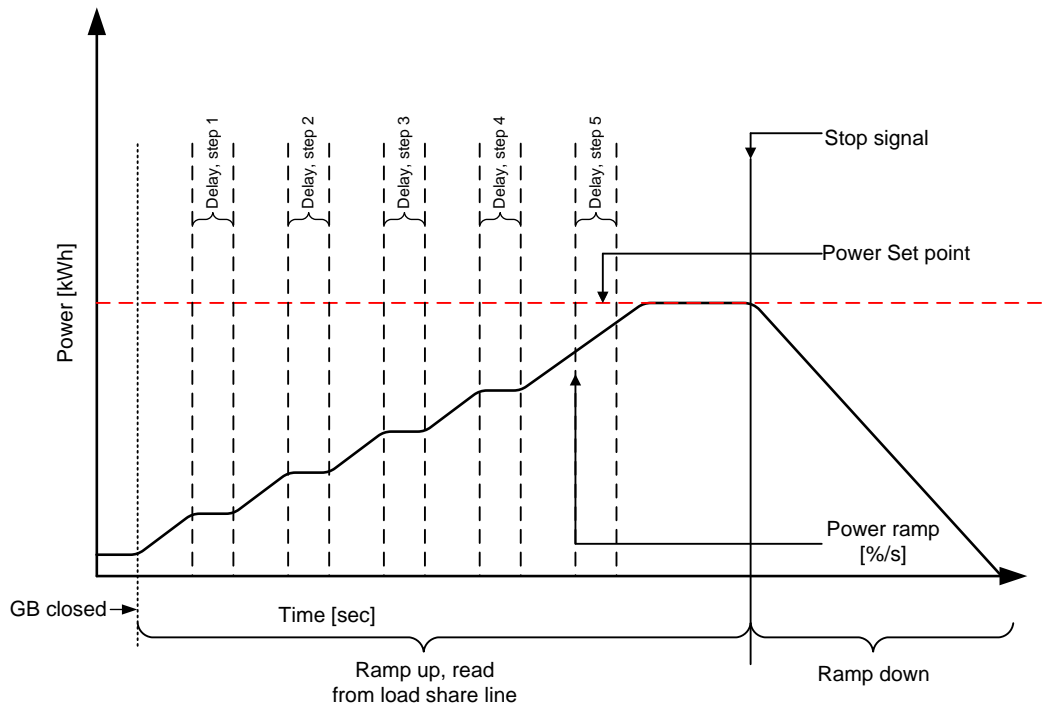

Freeze power ramp

A way to define the ramp up steps is to use the freeze power ramp command in M-Logic.

Freeze power ramp active:

1. The power ramp will stop at any point of the power ramp, and this set point will be maintained as long as the function is active.
2. If the function is activated while ramping from one delay point to another, the ramp will be fixed until the function is deactivated again.
3. If the function is activated while the delay timer is timing out, the timer will be stopped and will not continue until the function is deactivated again.



The delay starts running when the GB has been closed.

Available set points

Set points available in menu "2610 Power ramp up":

Ramp speed:	Defines the slope of the ramp up.
Delay point:	The size of each step.
Delay:	Delay at each step before continuing the ramp up.
Enable:	Enables the ramp up function in load sharing mode.
Steps:	Defines the number of ramp up steps.
Deadband:	Deadband for re-entering the ramp up/down sequence.

Ramp down function

When a GB open command has been issued in load sharing mode, the unit will always perform a ramp down before opening the breaker.

Set points available in menu "2620 Power ramp down":

Ramp speed:	Defines the slope of the ramp down.
Breaker open:	The amount of power accepted when opening the breaker.
Breaker open df:	The breaker will be tripped during ramp down in case the frequency drops more than the value defined in this setting.

 **During power ramp down in all modes, the voltage regulator, if active, must regulate towards power factor 1. This will ensure that current across the breaker is kept at a minimum.**

Distance

The inputs on the GPC-3 that are used for load sharing are high impedance inputs (23.5 kOhm), so a cable length of 300 metres is no problem.

 **Remember to always use screened cable.**

Load sharing type

The output from the GPC-3 is by default adjusted to match other Multi-line 2 and Uni-line products from DEIF A/S. This selection enables the load share output to operate in the 5 V DC range.

If the load share type is changed to "adjustable" (menu 6390), then the voltage level can be changed in the range 1.0 to 5.0 V DC (menu 6380). The advantage of this is that the load share output can be connected to or compared with other systems.

 **Careful testing must be carried out when different load sharing systems are interconnected. The reason is that not all systems can be interconnected and still function properly.**

If the load share type is changed to "Selco T4800", "Cummins PCC" or "Woodward SPM-D11", the voltage level of the load share line adapts to the required level of the selected load share type.

Load share controller

The load share controller is used whenever load sharing mode is activated. The load share controller is similar to the other controllers in the system, and it takes care of frequency control as well as power control.

Adjustment of the load share controller is done in menu 2540 (analogue control) or 2590 (relay control).

The primary purpose of the controller is always frequency control, because frequency is variable in a load sharing system and so is the power on the individual generator. Since the load sharing system requires power regulation as well, the controller can be affected by the power regulator. For this purpose a so-called weight factor is used (P weight).

The regulation deviation from the power regulator can therefore have great or less influence on the controller. An adjustment of 0 % means that the power control is switched off. An adjustment of 100 % means that the power regulation is not limited by the weight factor. Any adjustment in between is possible.

The difference between adjusting the weight value to a high or low value is the speed at which the power regulation deviation is eliminated. So if a firm load sharing is needed, the weight factor must be adjusted to a higher value than if an easy load sharing is required.

An expected disadvantage of a high weight factor is that when a frequency deviation and a power deviation exist, then hunting might occur. The solution to this is to decrease either the weight factor or the parameters of the frequency regulator.

4.14 Power limit set point

4.14.1 Four-stage power limit set point

This function is a way of giving external commands to the ML-2 unit for max. allowable produced power by digital inputs. The parameters are 10420 to 10423, and they are only accessible from the PC utility software.

USW	10420	P limit 1 value	1813	0
USW	10421	P limit 2 value	1814	30
USW	10422	P limit 3 value	1815	60
USW	10423	P limit 4 value	1816	100

Four set points are available. The set points indicate the maximum amount of power the ML-2 unit is allowed to produce from 0 to 100 %. Default set points are: value 1 = 0 %, value 2 = 30 %, value 3 = 60 % and value 4 = 100 %. These set points are configurable by the PC utility software.

Example: If set point 1 is set to 30 % and active, the ML-2 unit will produce max. 30 % of nominal power. If, for example, set points 1 and 3 are active at the same time, set point 1 will be used. Even if set point 1 is set to 60 % and set point 3 is set to 30 %, set point 1 will still be used.

The set points are activated by a digital input and are configured by M-Logic.

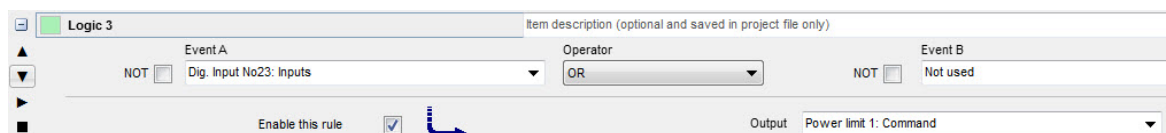

4.15 M-Logic

The M-Logic functionality is included in the unit and is not an option-dependent function; however, selecting additional I/O options can increase the functionality.

M-Logic is used to execute different commands at predefined conditions. M-Logic is not a PLC but substitutes one, if only very simple commands are needed.

M-Logic is a simple tool based on logic events. One or more input conditions are defined, and at the activation of those inputs, the defined output will occur. A great variety of inputs can be selected, such as digital inputs, alarm conditions and running conditions. A variety of the outputs can also be selected, such as relay outputs, change of genset modes and change of running modes.

 **The M-Logic is part of the PC utility software, and as such it can only be configured in the PC utility software and not via the display.**

The main purpose of M-Logic is to give the operator/designer more flexible possibilities of operating the generator control system.

 **Refer to the document “ML-2 application notes M-Logic” for a description of this configuration tool.**

The manual governor and AVR control function can be activated by pressing  more than two seconds, or by activating the digital inputs or AOP buttons for governor or AVR control in semi-auto mode. The intention of this function is to give the commissioning engineer a helpful tool for adjustment of the regulation.

When using the display arrows for increasing or decreasing, the output will change as long as the button is active. For the digital input and AOP buttons, there is a timer so that it is possible to choose how long one pulse should be; the timer can be set to 0.1 to 10 sec. For the governor, the timer parameter is 2782 and for AVR, it is 2784. If for example the timer is set to 5 sec., then one push on the AOP or one pulse from digital input will give 5 sec. increase or decrease of the output.

The function of the regulation window depends on the selected mode:

G	0	0	0V
P-Q Setp		100 %	100 %
P-Q Reg.		50 %	60 %
		<u>GOV</u>	AVR

4.16 Mode configuration

4.16.1 Manual mode

In manual mode the regulation is deactivated. When activating the up or down arrows, the output value to GOV or AVR is changed, this is the Reg. value in the display. The up and down arrows have the same function as the digital inputs or AOP buttons for governor and AVR control when the window is open. To exit the regulation window press "back".

Local/remote mode

As in manual mode, the up and down arrows have the same function as the digital inputs or AOP buttons for governor or AVR control when the window is open.

The value “Setp” can be changed by pressing the up or down arrow. When GOV is underlined, the governor set point will be changed, and vice versa when the AVR is underlined. When changing the “Setp” value, an offset will be added to or subtracted from the nominal value. The “Reg.” value is the output value from the regulator. If the genset is running in fixed P/Q, the active or reactive nominal power set point value will be changed. In fixed frequency/voltage, the nominal frequency or voltage set point will be changed and also displayed. When the “Back” button is activated, the regulation set point returns to nominal.

 **AVR set point manipulation requires option D1.**

 **Regarding AOP setup, refer to “Help” in the PC utility software.**

4.16.2 Not in remote

This function can be used for indication, or to raise an alarm in case the system is not in remote. The function is set up in menu 6370.

4.16.3 Modes active

The GPC-3 is designed to control the generator before, during and after synchronising. However, in rare cases it may become necessary to deactivate the regulation after the synchronising. This can be the case, for example if other load sharing equipment is installed or if an external power factor controller is installed. Adjust this in menu 2500.

 **The regulation will always be active when the circuit breaker is open. It is only possible to stop the regulation when the circuit breaker is closed.**

Principle

The diagrams below show that the regulation is active until the circuit breaker closes (during synchronising). When the circuit breaker closes, the regulation will only be active for the selected controller, the governor, the automatic voltage regulator or none of them.

Example 1, menu 2500 is adjusted to “SYNC + GOV + AVR”

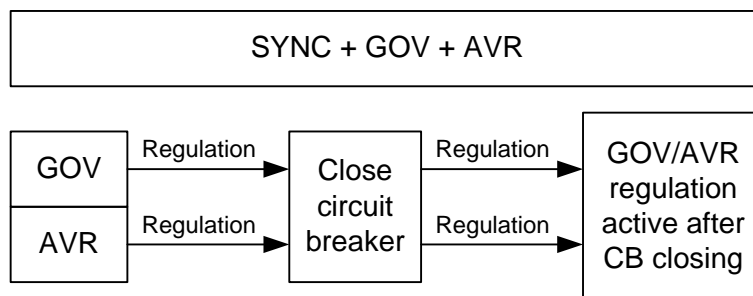

Example 2, menu 2500 is adjusted to "SYNC + GOV"

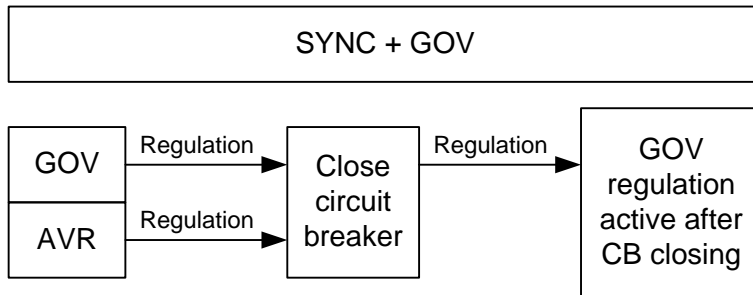

Example 3, menu 2500 is adjusted to "SYNC"

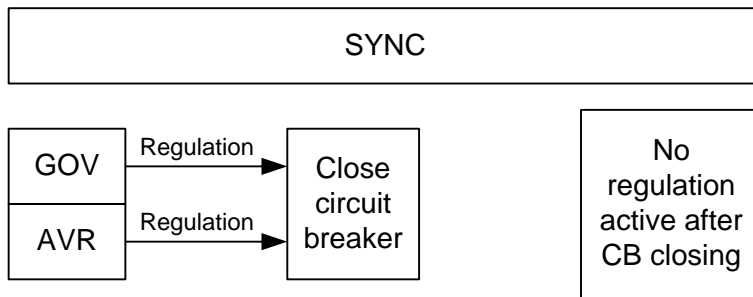

4.17 Nominal settings

The nominal settings can be changed to match different voltages and frequencies. The GPC has four sets of nominal values, and they are adjusted in menus 6000 to 6030 (nominal settings 1 to 4).

i The possibility to switch between the four sets of nominal set points is typically used in applications where switching between 50 and 60 Hz is required.

Activation

The switching between the nominal set points can be done in three ways: digital input, AOP or menu 6006.

Digital input

M-Logic is used when a digital input is needed for switching between the four sets of nominal settings. Select the required input among the input events, and select the nominal settings in the outputs.

Example:

Event A		Event B		Event C	Output
Dig. input no. 115	or	Not used	or	Not used	Set nom. parameter settings 1
Not Dig. input no. 115	or	Not used	or	Not used	Set nom. parameter settings 2

i See the "Help" file in the PC utility software for details.

AOP

M-Logic is used when the AOP is used for switching between the four sets of nominal settings. Select the required AOP push-button among the input events, and select the nominal settings in the outputs.

Example:

Event A		Event B		Event C	Output
Button07	or	Not used	or	Not used	Set nom. parameter settings 1
Button08	or	Not used	or	Not used	Set nom. parameter settings 2



See the “Help” file in the PC utility software for details.

Menu settings

In menu 6006, the switching is made between settings 1 to 4 simply by choosing the desired nominal setting.

Busbar

Two sets of nominal settings are available for the busbar (menus 6050 and 6060). Switching between the busbar nominal settings can only be done through M-Logic. For details, refer to the previous description about how to handle the generator nominal settings.

If required, the phase angle between the generator and busbar can be adjusted if a transformer is installed between generator and busbar. The adjustment is done in menu 9141 for busbar nominal settings 1 and in menu 9142 for busbar nominal settings 2.

4.18 Relay setup

The GPC-3 has several relay outputs available. Each of these relays can be given a special function depending on the required functionality. This is done in the I/O setup (menu 5000-5270).

Relay functions

Function	Description
Alarm relay NE	The relay is activated until the alarm that caused the activation is acknowledged and gone. The alarm LED is flashing or constant, depending on the acknowledged state.
Limit relay	The relay will activate at the limit set point. No alarm will appear when both outputs (OA/OB) of the alarm are adjusted to the limit relay. After the condition activating this relay has returned to normal, the relay will deactivate when the "OFF delay" has expired. The OFF delay is adjustable.
Horn relay	The output activates on all alarms. For a detailed description, refer to the chapter "Horn output".
Alarm/reset	The functionality is similar to "Alarm", but with a short-time reset (menu 5002) if the relay is ON and another alarm, set to the same relay, is activated.
Siren relay	The output activates on all alarms, like "Horn output". If the relay is ON and another alarm is active, a short-time reset (menu 5002) will be activated.
Alarm relay ND	The relay is activated until the alarm that caused the activation is acknowledged and gone. The alarm LED is flashing or constant, depending on the acknowledged state.
Common alarm	The output activates on all alarms, just like the "Horn" function. If the relay is ON and another alarm is active, a short-time reset will be activated. The common alarm output will be activated as long as there is an active alarm, also if the alarm is acknowledged.

The controller has a self-check function and a status relay output that responds to this function. The status relay is prepared for 24 V DC/1 A, and it is normally energised.

The self-check is monitoring the programme execution. Should this fail, that is in the unlikely event of micro-processor failure, then the self-check function deactivates the status relay.

Use the output from the status relay to perform a proper action for the genset application. Typically, this would mean a shutdown of the genset since it is now operating without protection and control.

 **The protections in the controller are not functioning when the self-check function deactivates the status relay.**

 **There are two "Self-check ok" LEDs on the controller. One is placed on the display and one on the main unit. The LEDs are lit when the unit is fully operational.**

4.18.1 Limit relay

For all alarm functions, it is possible to activate one or two output relays as shown below. This paragraph explains how to use an alarm function to activate an output without any indication of alarm. ON and OFF delay timers are described as well.

If no alarm is needed, it is possible to do one of the following things:

1. Set both output A and output B to Limit.
2. Set both output A and output B to the same specific terminal. If terminal alarm is not required, the set point in the specific relay is set to Limit relay.

In the example below, the relay will close when the generator voltage is above 103 % for 10 seconds, and no alarm will appear on the screen because both output A and output B are configured to relay 5, which is configured as "Limit relay".

Parameter "G U> 1" (Channel 1... ✕

Setpoint : 100 103 % 120

Timer : 0.1 10 sec 100

Fail class : Warning ▾

Output A Terminal 5 ▾

Output B Terminal 5 ▾

Password level : customer ▾

Enable
 High Alarm
 Inverse proportional

Auto acknowledge
Inhibits... ▾

★ Write OK Cancel

Commissioning

Actual value : 0 %

Actual timer value

0 sec 10 sec

The timer configured in the alarm window is an ON delay that determines the time during which the alarm conditions must be met before activation of any alarms or outputs.

When a relay is selected (relay on terminal 5 in this example), it must be set up as a limit relay as shown below, otherwise an alarm indication will still appear.

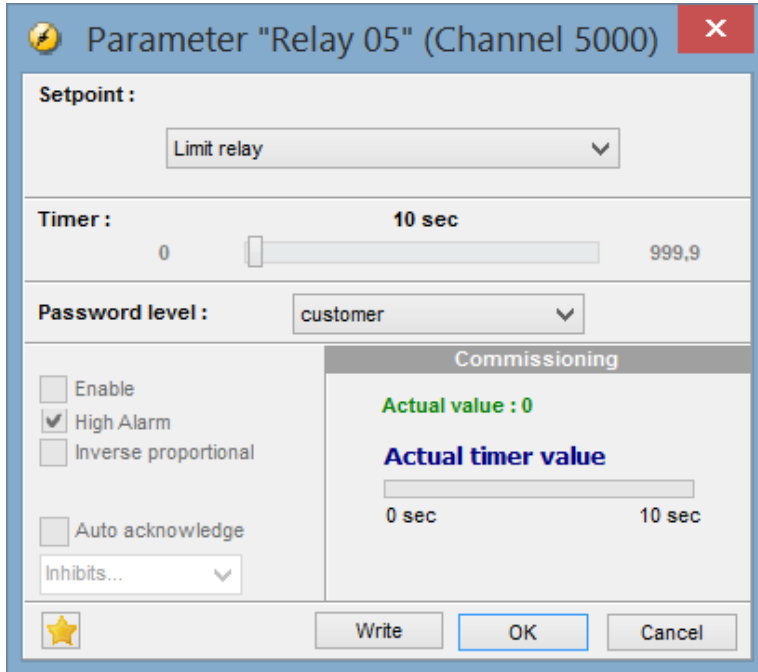

The timer in the image above is an OFF delay, meaning that when the alarm level is OK again, the relay will remain activated until the timer runs out. The timer is only effective when it is configured as "Limit relay". If it is configured to any "Alarm relay", the relay is deactivated instantly when the alarm conditions disappear and it is acknowledged.

4.19 Service menu

4.19.1 Service menu

The purpose of the service menu is to give information about the present operating condition of the genset. The service menu is entered using the "JUMP" push-button (9120 Service menu).

Use the service menu for easy troubleshooting in connection with the event log.

Entry window

The entry window shows the possible selections in the service menu.

G	0	0	0V
9120 Service menu			
Timers			
TIME	IN	OUT	MISC

TIME

Shows the alarm timer and the remaining time. The indicated remaining time is minimum remaining time. The timer will count downwards when the set point has been exceeded.

G	0	0	0V
1010 G	-P>		2
Remaining time			1.0s
UP	DOWN		

IN (digital input)

Shows the status of the digital inputs.

G	0	0	0V
Digital input	108		
Input =			1
UP	DOWN		

OUT (digital output)

Shows the status of the digital outputs.

G	0	0	0V
Relay 96			
Output A			0
UP	DOWN		

MISC

Shows the status of the M-Logic.

G	0	0	0V
M-Logic enabled			
Various =			1
UP	DOWN		

The load-dependent start/stop functionality uses one relay for “start next generator” and one relay for “stop next generator”. It is also possible just to use one of the functions if it is not desired to use both the start and the stop function.

The function load-dependent start and stop does not give the possibilities of a power management system, such as priority selection and available power calculations. This means that the switchboard manufacturer must take care of starting and stopping the next genset(s) and their priority.

The relays can be used as inputs for the power management system as an example.

Start next generator (high load) (menu 6520)

The below diagram shows that the delay for the start relay starts when the load exceeds the adjusted start limit. The relay will deactivate again when the load decreases below the start limit and the off delay has expired.

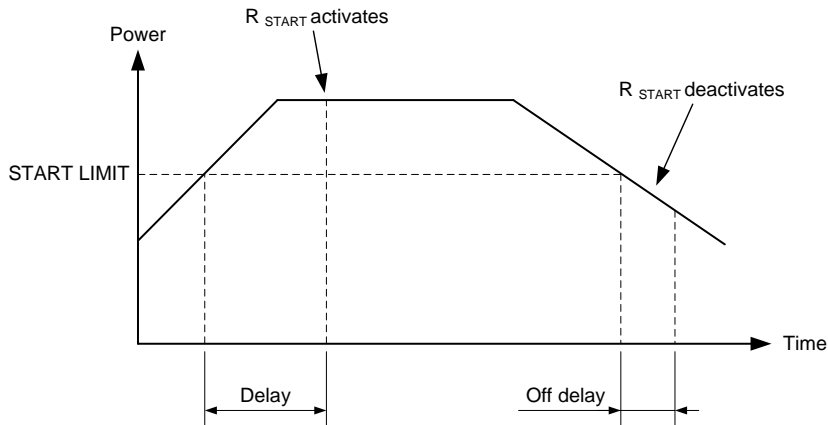

The load-dependent start relay reacts based on the power measurement of the controller together with the breaker closed feedback.

Stop next generator (low load) (menu 6530)

The diagram shows that the stop relay activates after a delay. The timer starts when the load drops below the adjusted stop level, and when the delay has expired, the relay activates.

The relay deactivates when the load exceeds the stop level when the off delay has expired. The off delay is adjustable.

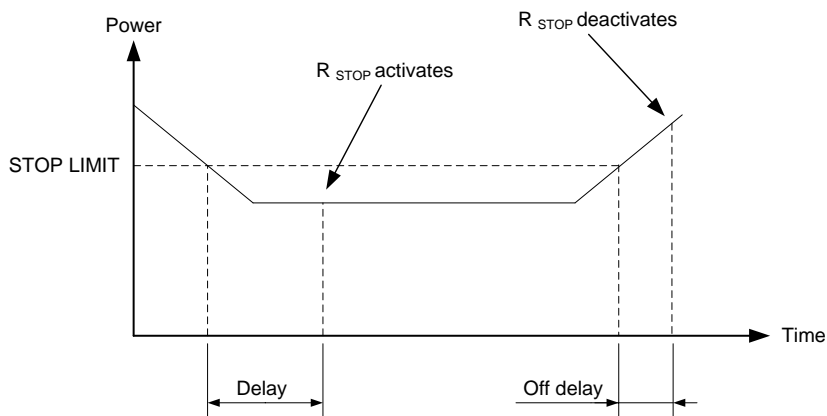

The load-dependent start relay reacts based on the power measurement of the controller together with the breaker closed feedback.

Configuration

The settings are configured through the display or through the PC utility software.

PC utility software configuration

Configuration of "Start next gen":

Parameter "Start next gen" (Channel 6520)

Setpoint :

50 80 % 100

Timer :

0 10 sec 100

Output A Not used

Output B Not used

Password level : Customer

Commissioning

Actual value : 0 %

Time elapsed : 0 sec (0 %)

0 sec 10 sec

Write OK Cancel

i Output A and output B must be adjusted to the same relay to avoid alarms when the set point is reached.

i When a relay has been selected for this function, it cannot be used for other functions.

Start/stop scenario

This diagram shows a (simplified) scenario where three DGs are started and stopped depending on the load-dependent start/stop relays.

The scenario shows that genset 2 starts when genset 1 reaches 80 %. The next genset to start is DG3, and the three sets load share at 53 %.

When the load of all three gensets drops to the stop limit, which is 20 %, the load-dependent stop relay activates and a genset (genset 3 in this example) can be stopped. The load continues to drop, and at 20 % load, the next genset to stop is genset 2.

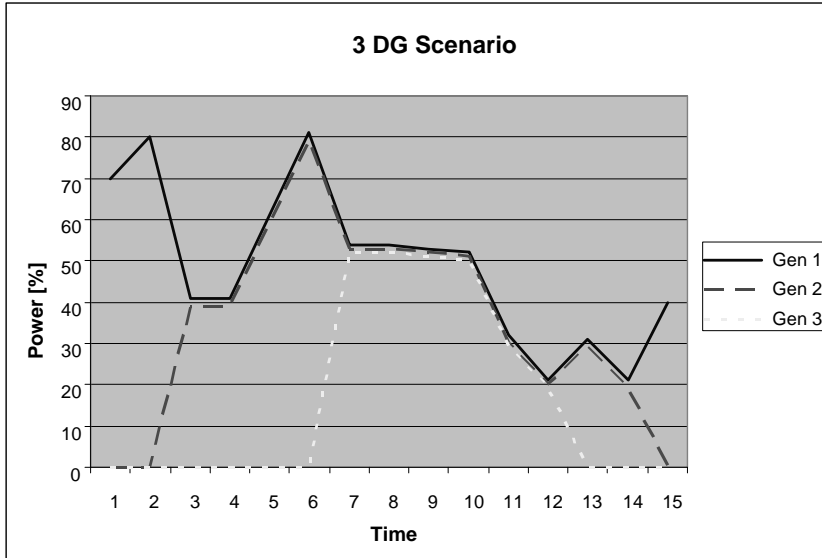

 The above is a simplified scenario.

4.20 Step-up and step-down transformer

4.20.1 Step-up transformer

In certain cases, the use of a generator with step-up transformer (called a block) is required. This may be to adapt to the closest grid voltage or to step up the voltage to minimise the losses in cables and also to bring down the cable size. The applications where a step-up transformer is needed, is supported by the ML-2. The functions available in this application are:

1. Synchronising with or without phase angle compensation
2. Voltage measurement displayed
3. Generator protections
4. Busbar protections

A diagram of a block is shown below

Generator/transformer block:

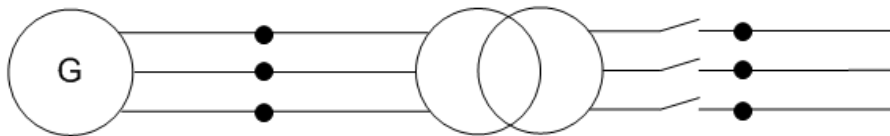

Typically the synchronising breaker is on the high voltage (HV) side, and there is no breaker (or only a manually operated one) on the low voltage (LV) side. In some applications, the breaker could also be placed on the LV side. But this does not influence on the setting in the ML-2, as long as the breaker and the step-up transformer are both placed between the measuring points for the ML-2. The measuring points are shown as black dots in the figures above and below.

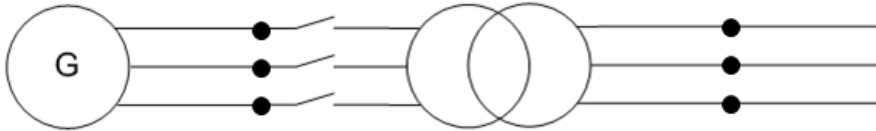

The phase angle compensation would not be an issue if there was no phase angle shift across the step-up transformer, but in many cases there is. In Europe, the phase angle shift is described using the vector group description. Instead of vector group, this could also be called clock notation or phase shift.



When voltage measurement transformers are used, these must be included in the total phase angle compensation.

When an ML-2 is used for synchronising, the device uses the ratio of the nominal voltages for the generator and the busbar, to calculate a set point for the AVR and the voltage synchronising window (dU_{MAX}).

Example:

A 10000 V/400 V step-up transformer is installed after a generator with the nominal voltage of 400 V. The nominal voltage of the busbar is 10000 V. Now, the voltage of the busbar is 10500 V. The generator is running 400 V before synchronising starts, but when attempting to synchronise, the AVR set point will be changed to:

$$U_{BUS-MEASURED} * U_{GEN-NOM} / U_{BUS-NOM} = 10500 * 400 / 10000 = 420 \text{ V}$$

4.20.2 Vector group for step-up transformer

Vector group definition

The vector group is defined by two letters and a number:

The first letter is an upper case D or Y, defining if the HV side windings are in delta or wye configuration.

The second letter is a lower case d, y or z, defining if the LV side windings are in delta, wye or zigzag configuration.

The number is the vector group number, defining the phase angle shift between HV and LV side of the step-up transformer. The number is an expression of the LV side lag compared to the HV side voltage. The number is an expression of the lag angle divided by 30 degrees.

Example:

Dy11 = HV side: Delta, LV side: Wye, vector group 11: Phase shift = $11 \times (-30) = -330$ degrees.

Typical vector groups

Vector group	Clock notation	Phase shift	LV lag degrees compared to HV
0	0	0 °	0 °
1	1	-30 °	30 °
2	2	-60 °	60 °
4	4	-120 °	120 °
5	5	-150 °	150 °
6	6	-180 °/180 °	180 °
7	7	150 °	210 °
8	8	120 °	240 °
10	10	60 °	300 °
11	11	30 °	330 °

Vector group 0

The phase shift is 0 degrees.

Yy0 example:

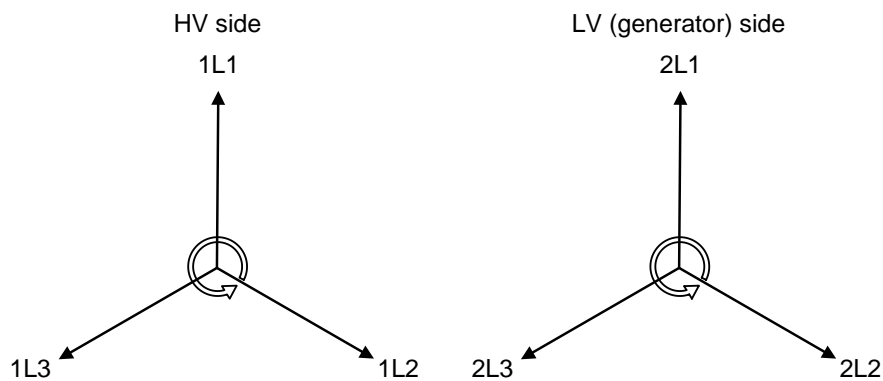

1L1 to 2L1 phase angle is 0 degrees

Phase compensation setting:

Parameter	Function	Setting
9141	BB (mains)/generator angle compensation	0 degrees

Connections:

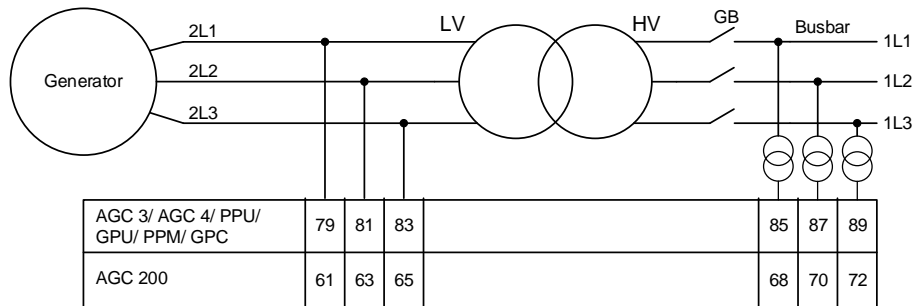

i The connection shown in the diagram should always be used when an ML-2 is used for a gen-set.

Vector group 1

The phase shift is -30 degrees.

Dy1 example:

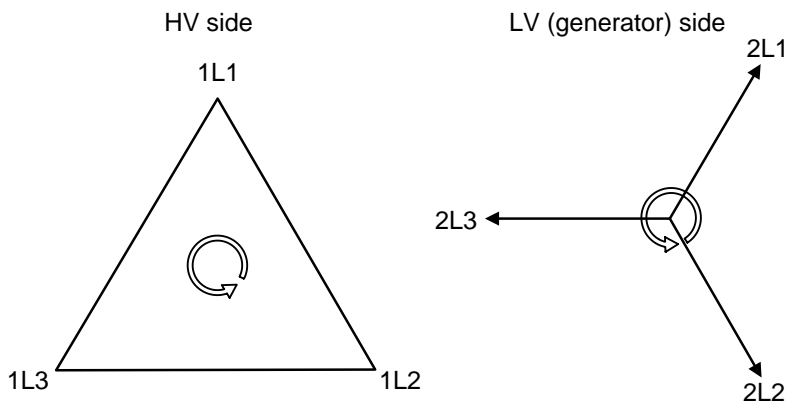

1L1 to 2L1 phase angle is -30 degrees.

Phase compensation setting:

Parameter	Function	Setting
9141	BB (mains)/generator angle compensation	30 degrees

Connections:

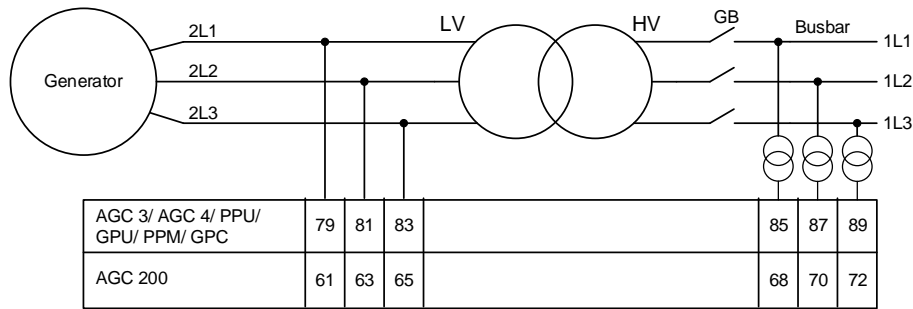

i The connection shown in the diagram should always be used when an ML-2 is used for a gen-set.

Vector group 11

The phase angle shift is $11 \times (-30) = -330/+30$ degrees.

Dy11 example:

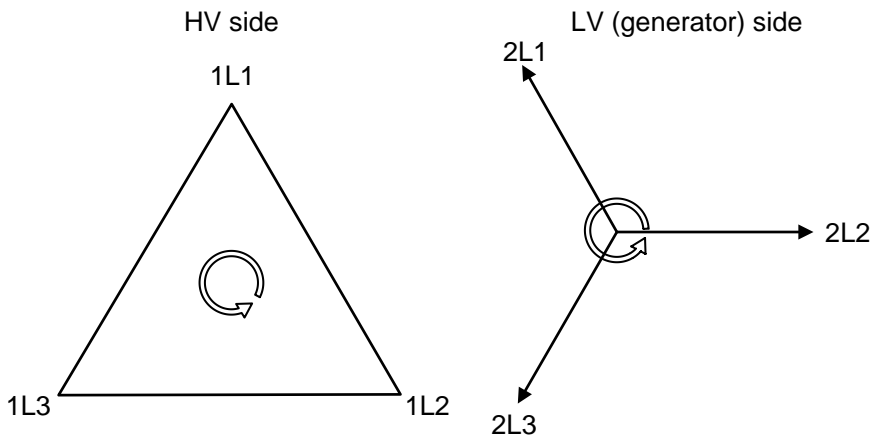

1L1 to 2L1 phase angle is $-330/+30$ degrees.

Phase compensation setting:

Parameter	Function	Setting
9141	BB (mains)/generator angle compensation	-30 degrees

Connections:

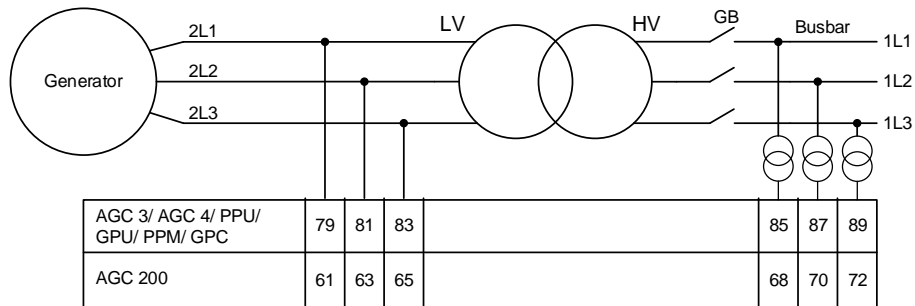

The connection shown in the diagram should always be used when an ML-2 is used for a genset.

Vector group 6

The phase angle shift is $6 \times 30 = 180$ degrees.

Yy6 example:

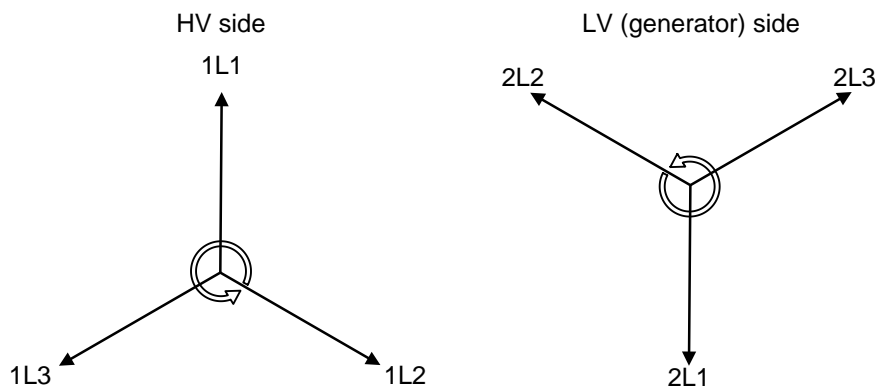

1L1 to 2L1 phase angle is $-180/+180$ degrees.

Phase compensation setting:

Parameter	Function	Setting
9141	BB (mains)/generator angle compensation	180 degrees

Connections:

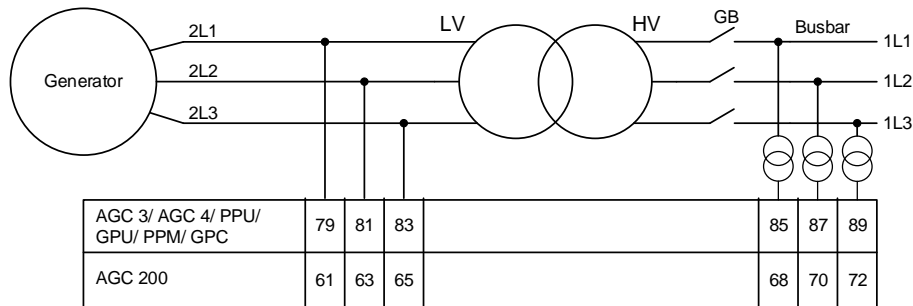

i The connection shown in the diagram should always be used when an ML-2 is used for a gen-set.

i Select 179 degrees in parameter 9141 when vector group 6 is used.





Comparison table between different terminologies:

Vector group	Clock notation	Phase shift	LV lag degrees compared to HV	LV side lagging	LV side leading
0	0	0 °	0 °	0 °	
1	1	-30 °	30 °	30 °	
2	2	-60 °	60 °	60 °	
4	4	-120 °	120 °	120 °	
5	5	-150 °	150 °	150 °	
6	6	-180 °/180 °	180 °	180 °	180 °
7	7	150 °	210 °		150 °
8	8	120 °	240 °		120 °
10	10	60 °	300 °		60 °
11	11	30 °	330 °		30 °

In the following, the name vector group will be used.

Table to read parameter 9141 compared to a step-up transformer:

Vector group	Step-up transformer types	Parameter 9141
0	Yy0, Dd0, Dz0	0 °
1	Yd1, Dy1, Yz1	30 °
2	Dd2, Dz2	60 °
4	Dd4, Dz4	120 °
5	Yd5, Dy5, Yz5	150 °
6	Yy6, Dd6, Dz6	180 °
7	Yd7, Dy7, Yz7	-150 °
8	Dd8, Dz8	-120 °
10	Dd10, Dz10	-60 °
11	Yd11, Dy11, Yz11	-30 °

-  **DEIF does not take responsibility that the compensation is correct. Before closing the breaker, DEIF recommends that customers always measure the synchronisation themselves.**
-  **If voltage measurement is connected incorrectly, the setting in parameter 9141 will be wrong.**
-  **The setting shown in the table above does not include any phase angle twist made by measurement transformers.**
-  **The settings shown in the table above are not correct if a step-down transformer is used. These settings are shown later.**

4.20.3 Setup of step-up transformer and measurement transformer

If the HV side of the transformer is transforming the voltage up to a voltage level higher than 690 V AC, it will be necessary with measurement transformers. The setup of all these parameters can be done from the utility software, and will be explained by an example:

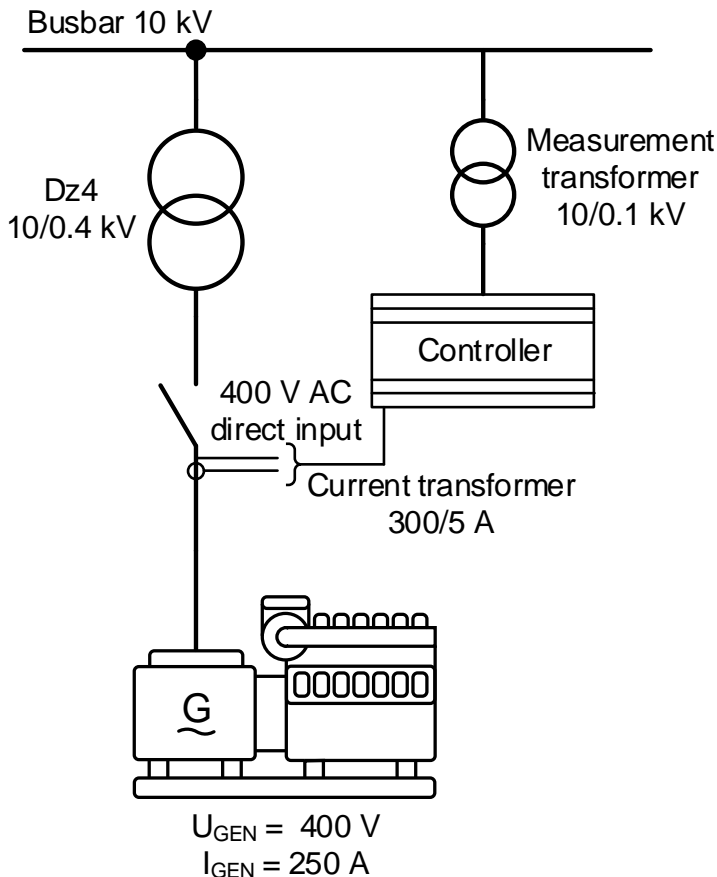

The transformer is a Dz4 step-up transformer, with nominal settings of 10/0.4 kV.

The generator has a nominal voltage of 0.4 kV, nominal current of 250 A, and a nominal power of 140 kW.

The measurement transformer has a nominal voltage of 10/0.1 kV, and no phase angle twist.

The nominal voltage of the busbar (BB) is 10 kV.

Because the generator's nominal voltage is 400 V, there is no need for a measurement transformer on the LV side in this example. The ML-2 can handle up to 690 V. But it is still required to set up current transformers on the LV side. In this example, the current transformers have a nominal current of 300/5 A.

Due to the fact that the step-up transformer is a Dz4, there will be a phase angle twist of -120 °.

These settings can be programmed via the display or the utility software. These settings must be put into the parameters shown in the table below:

Parameter	Comment	Setting
6002	Generator nominal power	140
6003	Generator nominal current	250
6004	Generator nominal voltage	400
6041	LV measurement transformer primary side (There is none here)	400
6042	LV measurement transformer secondary side (There is none here)	400
6043	Current transformer primary side	300
6044	Current transformer secondary side	5
6051	HV (BB) measurement transformer primary side	10000
6052	HV (BB) measurement transformer secondary side	100
6053	Nominal HV setting of step-up transformer	10000
9141	Phase angle compensation	120 °

 The ML-2 controller can directly handle voltage levels between 100 and 690 V. If the voltage level in the application is higher or lower, it is required to use measurement transformers that transform the voltage into a number between 100 and 690 V.

4.20.4 Vector group for step-down transformer

In some applications, there may also be a step-down transformer. This could be to transform a grid voltage down, so the load can handle the voltage level. The ML-2 controller is able to synchronise the busbar with the mains, even if there is a step-down transformer with a phase angle twist. The transformer must be between the measuring points for ML-2. If a step-down transformer is used, these settings will must be set in parameter 9141 to compensate the phase angle twist.

Vector group	Step-up transformer types	Parameter 9141
0	Yy0, Dd0, Dz0	0 °
1	Yd1, Dy1, Yz1	-30 °
2	Dd2, Dz2	-60 °
4	Dd4, Dz4	-120 °
5	Yd5, Dy5, Yz5	-150 °
6	Yy6, Dd6, Dz6	180 °
7	Yd7, Dy7, Yz7	150 °
8	Dd8, Dz8	120 °
10	Dd10, Dz10	60 °
11	Yd11, Dy11, Yz11	30 °

 If a step-down transformer is mounted with an ML-2 genset unit, the settings shown in the table above should also be used.

If a step-down transformer and an ML-2 for the mains breaker are mounted, note how the measurements are mounted on the ML-2. The correct connection is shown below.

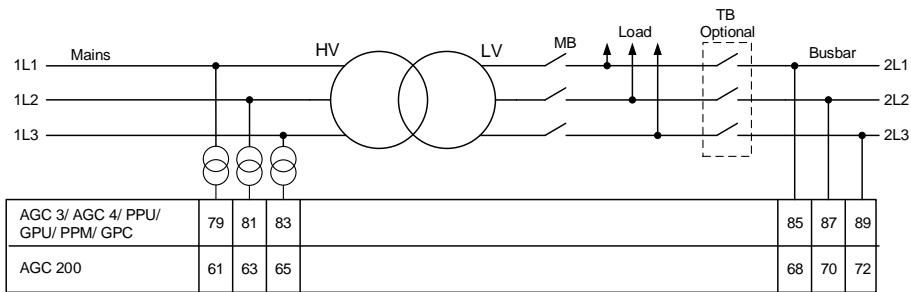

The connection shown in the picture should always be used when an ML-2 is used for a mains breaker.

4.20.5 Setup of step-down transformer and measurement transformer

If the HV side of the transformer has a voltage level higher than 690 V AC, it will be necessary with measurement transformers. In this example, the HV side is 690 V, and therefore there is no need for a measurement transformer. The step-down transformer can have a phase angle twist, which must be compensated for. The setup of all the parameters can be done from the utility software, and will be explained by an example:

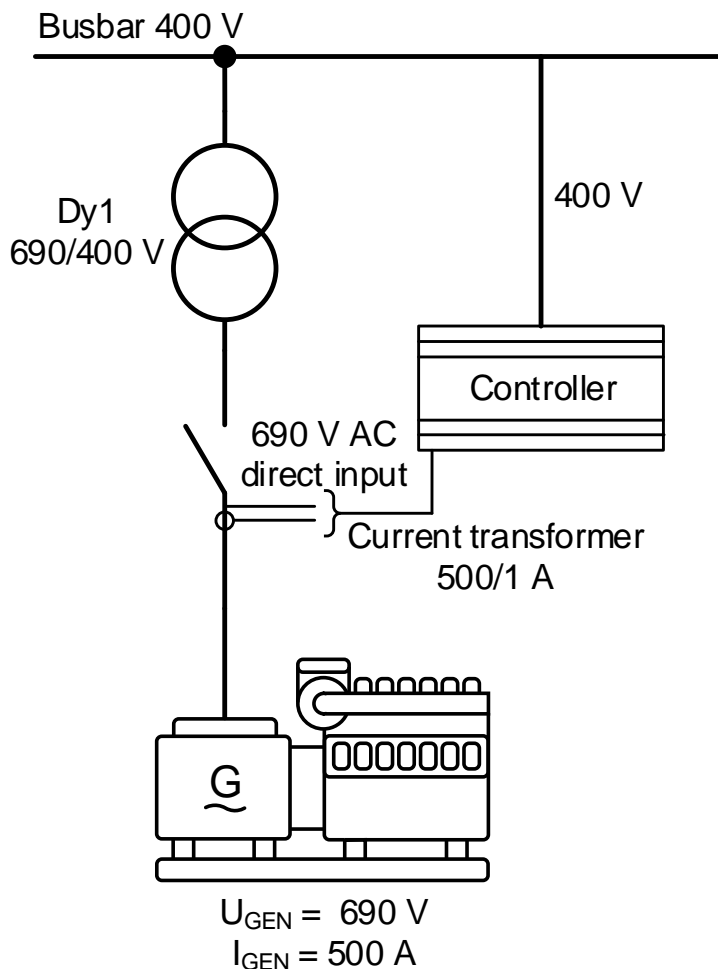

The transformer is a Dy1 step-down transformer, with nominal settings of 690/400 V.

The generator has a nominal voltage of 690 V, nominal current of 500 A and a nominal power of 480 kW.

There is no measurement transformer in this application, because the ML-2 is able to handle the voltage levels directly.

The nominal voltage of the busbar (BB) is 400 V.

It is still required to set up current transformers. In this example, the current transformers have a nominal current of 500/1 A.

Due to the fact that the step-down transformer is a Dy1, there will be a phase angle twist of +30 °.

These settings can be programmed via the display or the utility software. These settings must be put into the parameters shown in the table below:

Parameter	Comment	Setting
6002	Generator nominal power	480
6003	Generator nominal current	500
6004	Generator nominal voltage	690
6041	HV measurement transformer primary side (There is none here)	690
6042	HV measurement transformer secondary side (There is none here)	690
6043	Current transformer primary side	500
6044	Current transformer secondary side	1
6051	LV (BB) measurement transformer primary side (There is none here)	400
6052	LV (BB) measurement transformer secondary side (There is none here)	400
6053	Nominal LV setting of step-up transformer	400
9141	Phase angle compensation	-30 °

5. Protections

5.1 Protections

5.1.1 General

The protections are all of the definite time type, that is a set point and time is selected.

If, for example, the function is over-voltage, the timer will be activated if the set point is exceeded. If the voltage value falls below the set point value before the timer runs out, the timer will be stopped and reset.

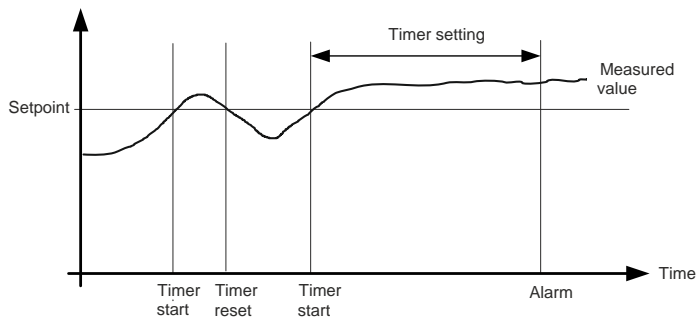

When the timer runs out, the output is activated. The total delay will be the delay setting + the reaction time.

When parameterising the DEIF controller, the measuring class of the controller and an adequate "safety" margin must be taken into consideration.

An example:



A power generation system must not reconnect to a network when the voltage is 85 % of U_n $\pm 0\%$ $\leq U \leq 110\%$ $\pm 0\%$. In order to ensure reconnection within this interval, a control unit's tolerance/accuracy (Class 1 of the measuring range) has to be taken into consideration. It is recommended to set a control unit's setting range 1 to 2 % higher/lower than the actual set point, if the tolerance of the interval is $\pm 0\%$, to ensure that the power system does not reconnect outside the interval.

Phase-neutral voltage trip

If the voltage alarms are to work based on phase-neutral measurements, you must adjust menus 1200 and 1340 accordingly. Depending on the selections, either phase-phase voltages or phase-neutral voltages will be used for the alarm monitoring.

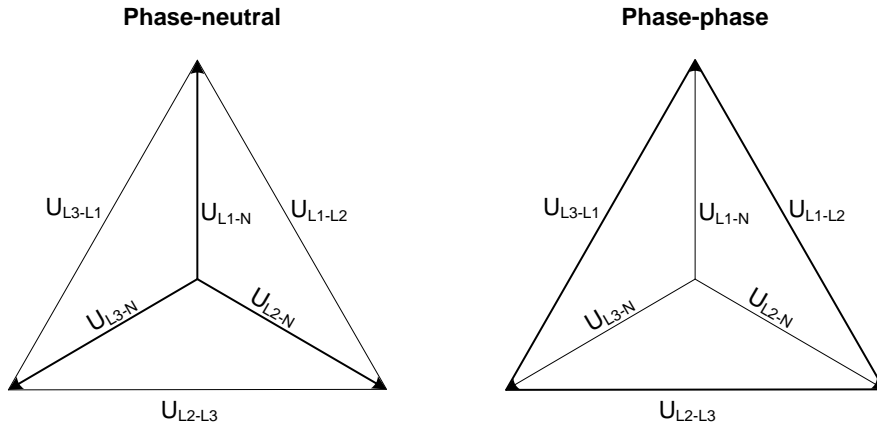

As indicated in the vector diagram, there is a difference in voltage values at an error situation for the phase-neutral voltage and the phase-phase voltage.

The table shows the actual measurements at a 10 % under-voltage situation in a 400/230 volt system.

	Phase-neutral	Phase-phase
Nominal voltage	400/230	400/230
Voltage, 10 % error	380/207	360/185

The alarm will occur at two different voltage levels, even though the alarm set point is 10 % in both cases.

Example

The below 400 V AC system shows that the phase-neutral voltage must change 20 %, when the phase-phase voltage changes 40 volts (10 %).

Example:

$U_{NOM} = 400/230 \text{ V AC}$

Error situation:

$U_{L1L2} = 360 \text{ V AC}$

$U_{L3L1} = 360 \text{ V AC}$

$U_{L1-N} = 185 \text{ V AC}$

$\Delta U_{PH-N} = 20 \%$

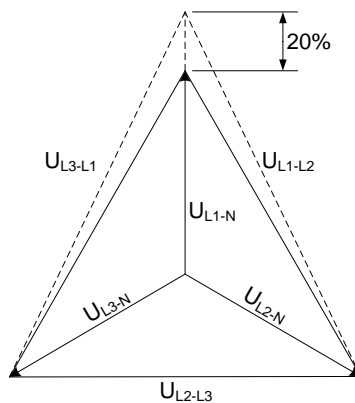



i Phase-neutral or phase-phase: both the generator protections and the busbar/mains protections use the selected voltage.

The protection calculates the over-current set point as a function of the measured voltage on the generator voltage terminals.

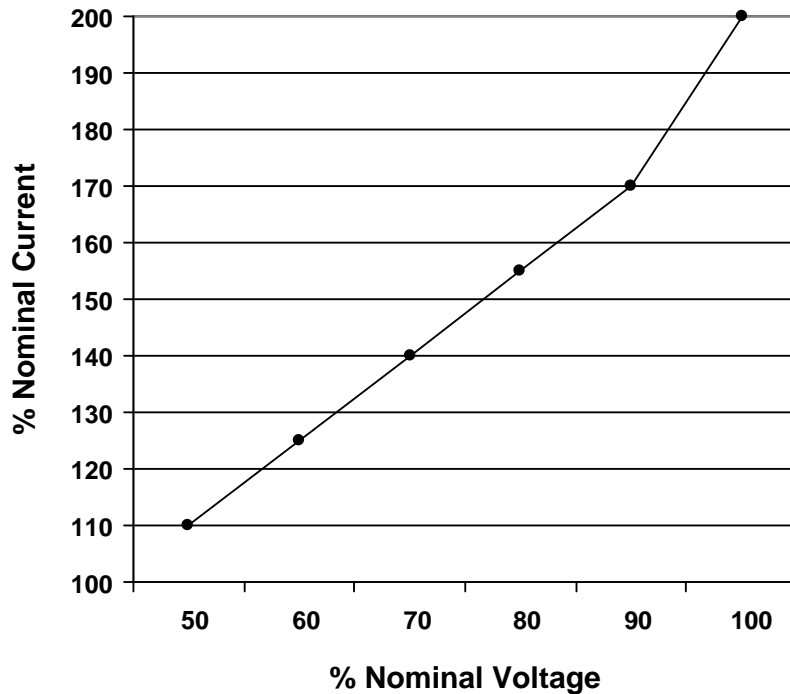
The result can be expressed as a curve function:



This means that if the voltage drops, the over-current set point will also drop.

-  The voltage values for the six points on the curve are fixed; the current values can be adjusted in the range 50 to 200 %.
-  Voltage and current % values refer to the nominal settings.
-  Timer value can be adjusted in the range 0.1 to 10.0 s.

5.2 Inverse time over-current

Formula and settings used

The inverse time over-current is based on IEC 60255 part 151.

The function used is **dependent time characteristic**, and the formula used is:

$$t(G) = TMS \left(\frac{k}{\left(\frac{G}{G_s} \right)^\alpha - 1} + C \right)$$

where

$t(G)$ is the theoretical operating time constant value of G in seconds
 k, c, α are the constants characterising the selected curve
 G is the measured value of the characteristic quantity
 G_S is the setting value
 TMS is the time multiplier setting

The constants k and c have a unit of seconds, α has no dimension.



There is no intentional delay on reset. The function will reset when $G < G_S$.

Curve shapes

Time characteristic:

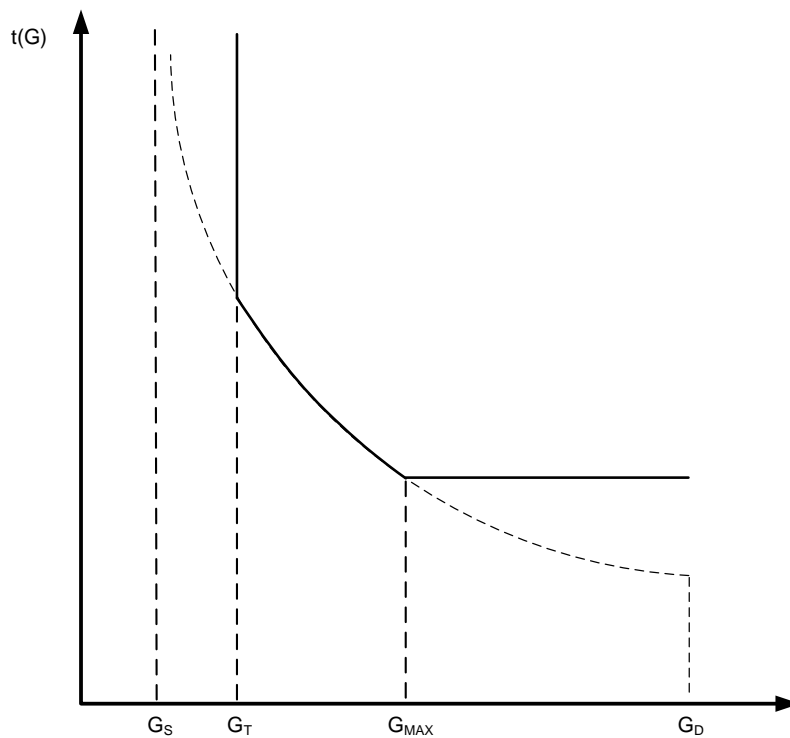

$$G_S = I_{nom} \times LIM$$

$$G_T = 1.1 \times G_S$$

$$G_{MAX} = 2.2 \times CT_p$$

G_T : Minimum trip current

G_{MAX} : Maximum trip current

I_{nom} : Nominal current setting

CT_p : Current transformer primary

There is a choice between seven different curve shapes, of which six are predefined and one is user-definable:

IEC Inverse
 IEC Very Inverse
 IEC Extremely Inverse
 IEEE Moderately Inverse
 IEEE Very Inverse
 IEEE Extremely Inverse
 Custom

Common settings for all types:

Setting	Parameter no.	Factory setting value	Equals
LIM	1082	110 %	$LIM = G_S / I_{nom}$
TMS	1083	1.0	Time multiplier setting

The following constants apply to the predefined curves:

Curve type	k	c	α
IEC Inverse	0.14	0	0.02
IEC Very Inverse	13.5	0	1
IEC Extremely Inverse	80	0	2
IEEE Moderately Inverse	0.515	0.1140	0.02
IEEE Very Inverse	19.61	0.491	2
IEEE Extremely Inverse	28.2	0.1217	2

For the custom curve, these constants can be defined by the user:

Setting	Parameter no.	Factory setting value	Equals
k	1084	0.140 s	k
c	1085	0.000 s	c
α	1086	0.020	α



For the actual setting ranges, see the separate parameter list document.

Standard curves

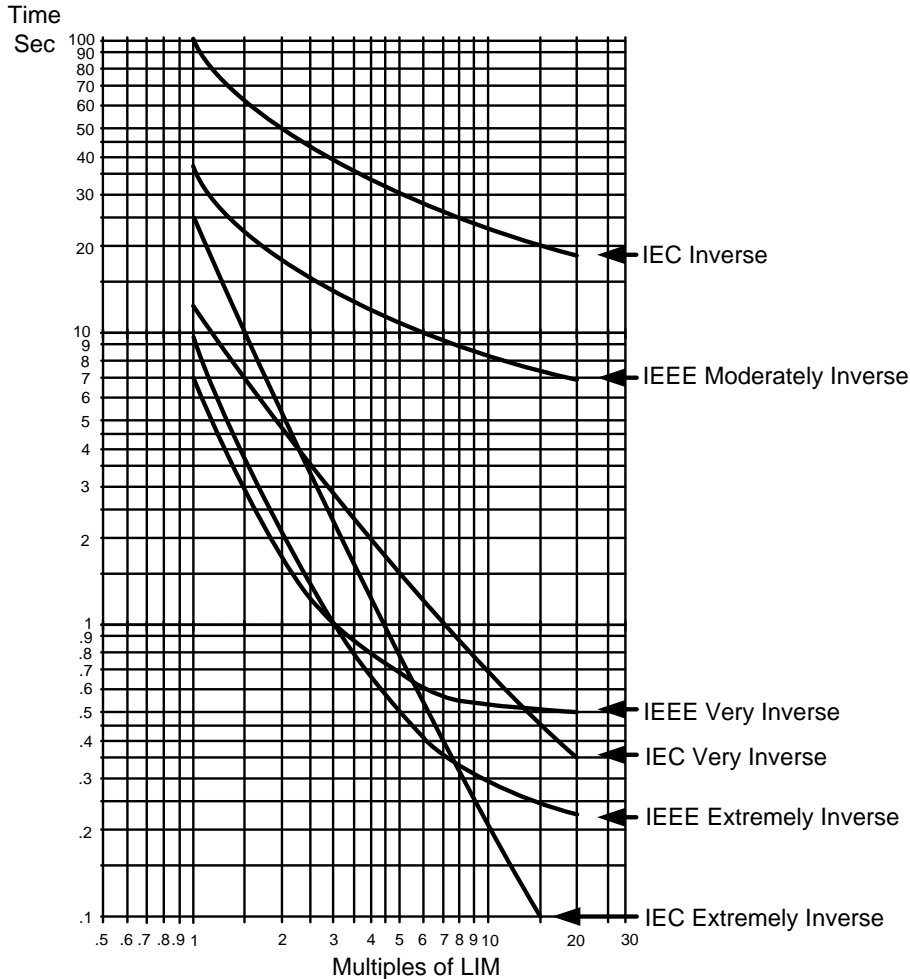

i The curves are shown for TMS = 1.

5.3 Reverse power

Two characteristics are available for the reverse power protections; definite (default) and inverse.

If inverse characteristic is selected, the tripping time is dependent on how much the set point is exceeded. The unit will calculate the exact tripping time depending on the alarm settings. The alarm settings define a certain amount of energy that defines the longest possible tripping time.

When the set point is exceeded, the measured energy is calculated according to the set point and the time delay. If this value is exceeded, the alarm occurs. The maximum energy (kWh) will never be exceeded, so if the reverse power increases, the time delay will decrease and vice versa.

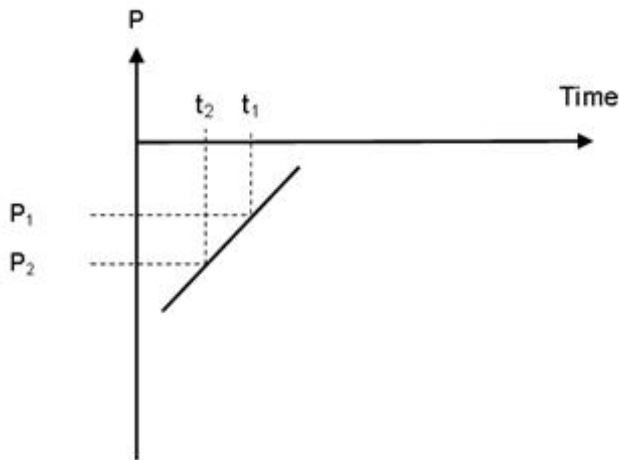

The diagram above shows that when the reverse power increases from P_1 to P_2 , the delay will also be shorter.

Settings related to reverse power protection:

1000 G -P> 1 AND 1010 G -P> 2

Set point:	Reverse power protection limit
Delay:	Time delay
Output A:	Select alarm output A
Output B:	Select alarm output B
Enable:	Enable/disable the protection
Fail class:	Action when protection is activated

1020 G -P> characteristic

Char. 1:	Tripping characteristic for "1000 G -P> 1"
Char. 2:	Tripping characteristic for "1010 G -P> 2"

5.4 Trip of Non-Essential Load (NEL)

The trip of Non-Essential Load (NEL) groups is carried out in order to protect the busbar against an imminent blackout situation due to either a high load/current or overload on a generator set or a low busbar frequency.

The unit is able to trip three NEL groups due to:

- the measured load of the generator set (high load and overload)
- the measured current of the generator set
and
- the measured frequency at the busbar.

The load groups are tripped as individual load groups. This means that the trip of load group no. 1 has no direct influence on the trip of load group no. 2. **Only** the measurement of either the busbar frequency or the load/current on the generator set is able to trip the load groups.

Trip of the NEL groups due to the load of a running generator set will reduce the load on the busbar and thus reduce the load percentage on the running generator set. This may prevent a possible blackout at the busbar caused by an overload on the running generator sets.

NEL groups are set up in menu 1800 to 1910.

5.5 Reset ratio (hysteresis)

The reset ratio, also known as hysteresis, of the individual types of protections (f, Q/P, I and U) can be adjusted in menu 9040. Use the jump function to access this menu.

6. PID controller

6.1 PID controller

The PID controller consists of a proportional regulator, an integral regulator and a differential regulator. The PID controller is able to eliminate the regulation deviation and can easily be tuned in.

 For details about tuning the controllers, refer to the document “General Guidelines for Commissioning”.

There are three controllers for the governor control and, if option D1 is selected, also three controllers for the AVR control.

Controller	GOV	AVR	Comment
Frequency sync.	X		Controls the frequency during synchronisation (GB OFF)
Frequency	X		Controls the frequency and frequency droop
Power	X		Controls the power in fixed power and during ramp up/down
P load sharing	X		Controls the active power load sharing
Voltage (option D1)		X	Controls the voltage and voltage droop
Reactive power (option D1)		X	Controls the power factor and reactive power
Q load sharing (option D1)		X	Controls the reactive power load sharing

The tables below indicate when each of the controllers is active. This means that the controllers can be tuned in when the shown running situations are present.

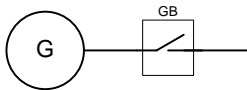
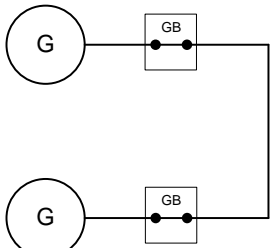
Governor			AVR (option D1)			Schematic
Frequency	Power	P LS	Voltage	var	Q LS	
X			X			
		X			X	

The drawing below shows the basic principle of the PID controller.

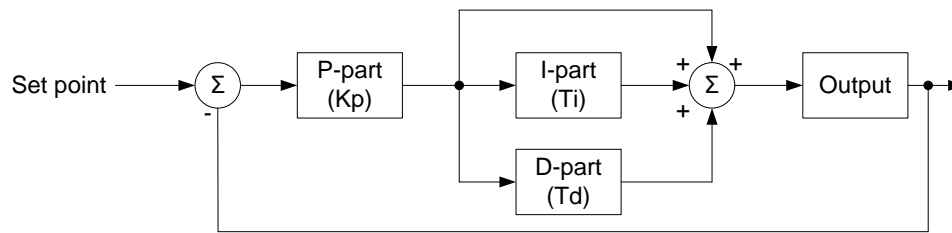

$$PID(s) = K_p \cdot \left(1 + \frac{1}{T_i \cdot s} + T_d \cdot s \right)$$

As illustrated in the above drawing and equation, each regulator (P, I and D) gives an output which is summarised to the total controller output.

The adjustable settings for the PID controllers in the GPC-3 unit are:

- K_p: The gain for the proportional part.
- T_i: The integral action time for the integral part.
- T_d: The differential action time for the differential part.

The function of each part is described in the following.

6.2 Proportional regulator

When the regulation deviation occurs, the proportional part will cause an immediate change of the output. The size of the change depends on the gain K_p.

The diagram shows how the output of the P regulator depends on the K_p setting. The change of the output at a given K_p setting will be doubled if the regulation deviation doubles.

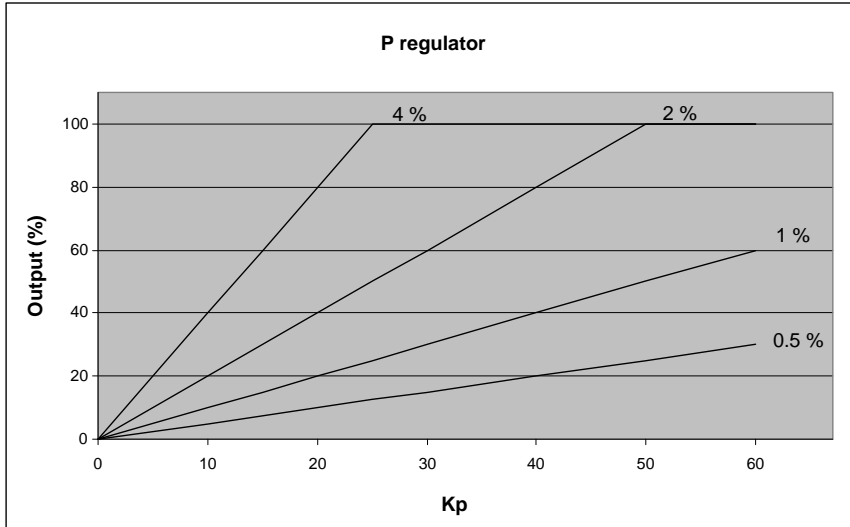

Speed range

Because of the characteristic above, it is recommended to use the full range of the output to avoid an unstable regulation. If the output range used is too small, a small regulation deviation will cause a rather big output change. This is shown in the drawing below.

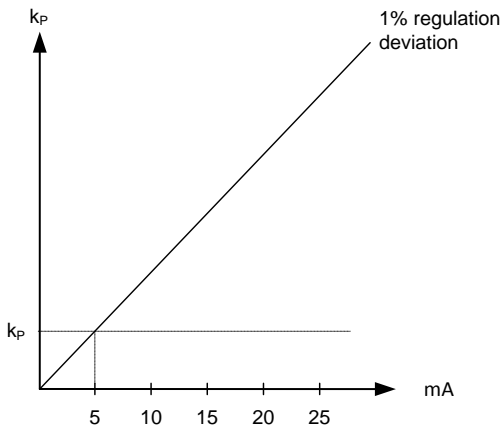

A 1 % regulation deviation occurs. With the K_p setting adjusted, the deviation causes the output to change 5 mA. The table shows that the output will change relatively much, if the maximum speed range is low.

Max. speed range	Output change		Output change in % of max. speed range
10 mA	5 mA	$5/10 \cdot 100 \%$	50
20 mA	5 mA	$5/20 \cdot 100 \%$	25

Dynamic regulation area

The drawing below shows the dynamic regulation area at given values of K_p . The dynamic area gets smaller, if the K_p is adjusted to a higher value.

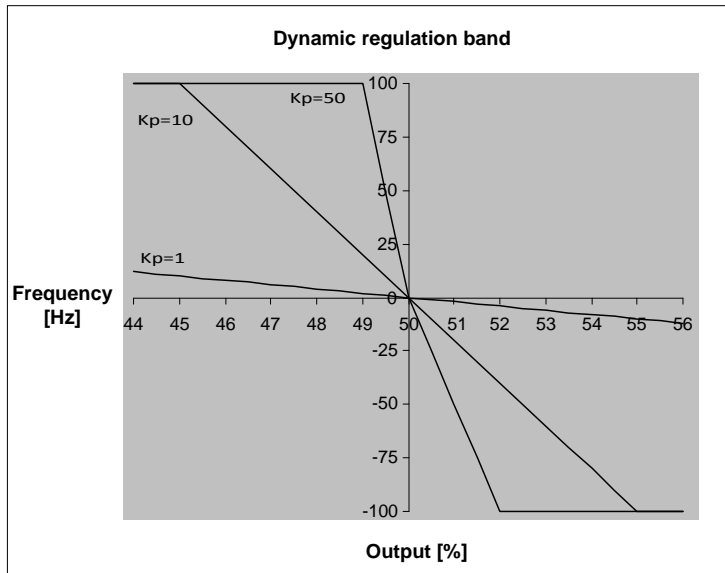
**Integral regulator**

The main function of the integral regulator is to eliminate offset. The integral action time, T_i , is defined as the time the integral regulator uses to replicate the momentary change of the output caused by the proportional regulator.

In the drawing below, the proportional regulator causes an immediate change of 2.5 mA. The integral action time is then measured when the output reaches $2 \times 2.5 \text{ mA} = 5 \text{ mA}$.

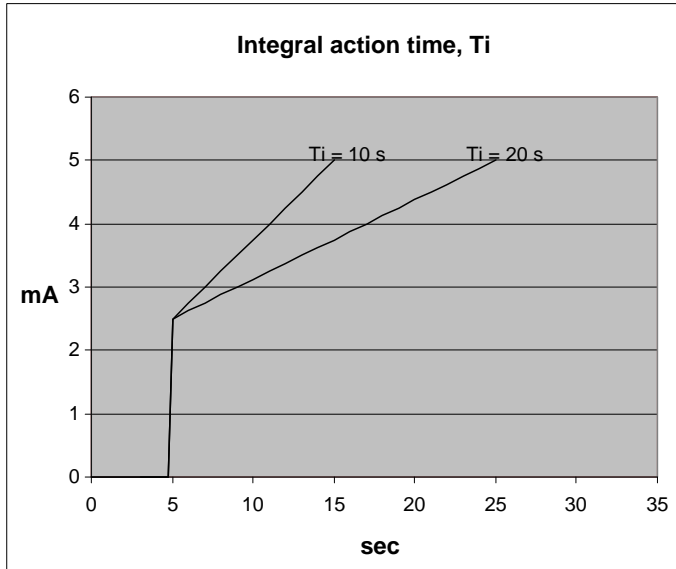

As it appears from the drawing, the output reaches 5 mA twice as fast at a T_i setting of 10 s than with a setting of 20 s.

The integrating function of the I-regulator is increased if the integral action time is decreased. This means that a lower setting of the integral action time, T_i , results in a faster regulation.



If the T_i is adjusted to 0 s, the I-regulator is switched OFF.



The integral action time, T_i , must not be too low. This will make the regulation hunt, similar to a too high proportional action factor, K_p .

Differential regulator

The main purpose of the differential regulator (D-regulator) is to stabilise the regulation, thus making it possible to set a higher gain and a lower integral action time, T_i . This will make the overall regulation eliminate deviations much faster.

In most cases, the differential regulator is not needed; however, in case of very precise regulation situations, for example static synchronisation, it can be very useful.

$$D = T_d \cdot K_p \cdot \frac{de}{dt}$$

The output from the D-regulator can be explained with the equation:

D = regulator output

K_p = gain

de/dt = slope of the deviation (how fast does the deviation occur)

This means that the D-regulator output depends on the slope of the deviation, the K_p and the T_d setting.

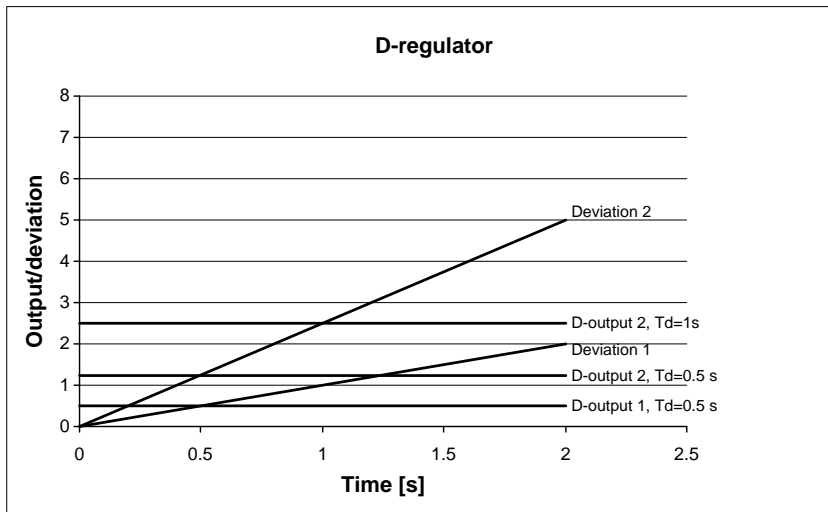

Example:

In the following example, it is assumed that $K_p = 1$.



- Deviation 1: A deviation with a slope of 1.
- Deviation 2: A deviation with a slope of 2.5 (2.5 times bigger than deviation 1).
- D-output 1, Td=0.5 s: Output from the D-regulator when Td=0.5 s and the deviation is according to Deviation 1.
- D-output 2, Td=0.5 s: Output from the D-regulator when Td=0.5 s and the deviation is according to Deviation 2.
- D-output 2, Td=1 s: Output from the D-regulator when Td=1 s and the deviation is according to Deviation 2.

The example shows that the bigger deviation and the higher Td setting, the bigger output from the D-regulator. Since the D-regulator is responding to the slope of the deviation, it also means that when there is no change, the D-output will be zero.

-  **When commissioning, keep in mind that the Kp setting has influence on the D-regulator output.**
-  **If the Td is adjusted to 0 s, the D-regulator is switched OFF.**
-  **The differential action time, Td, must not be too high. This will make the regulation hunt, similar to a too high proportional action factor, Kp.**

6.3 Relay control

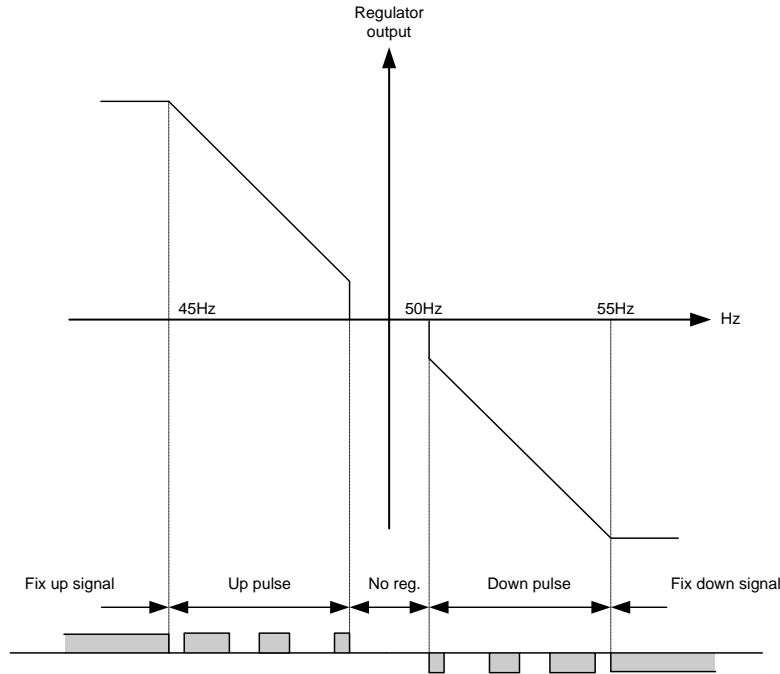

The regulation with relays can be split up into five steps.

#	Range	Description	Comment
1	Static range	Fixed up signal	The regulation is active, but the increase relay will be constantly activated because of the size of the regulation deviation.
2	Dynamic range	Up pulse	The regulation is active, and the increase relay will be pulsing in order to eliminate the regulation deviation.
3	Deadband area	No reg.	In this particular range no regulation takes place. The regulation accepts a predefined deadband area in order to increase the lifetime of the relays.
4	Dynamic range	Down pulse	The regulation is active, and the decrease relay will be pulsing in order to eliminate the regulation deviation.
5	Static range	Fixed down signal	The regulation is active, but the decrease relay will be constantly activated because of the size of the regulation deviation.

As the drawing indicates, the relays will be fixed ON if the regulation deviation is big, and they will be pulsing if it is closer to the set point. In the dynamic range, the pulses get shorter and shorter when the regulation deviation gets smaller. Just before the deadband area, the pulse is as short as it can get. This is the adjusted time "GOV ON time". The longest pulse will appear at the end of the dynamic range (45 Hz in the example above).

Relay adjustments

The time settings for the regulation relays can be adjusted in the control setup. It is possible to adjust the "GOV period time" and the "GOV ON time".

As it is indicated in the drawing below, the length of the relay pulse will depend on the actual regulation deviation. If the deviation is big, the pulses will be long (or a continued signal). If the deviation is small, the pulses will be short.

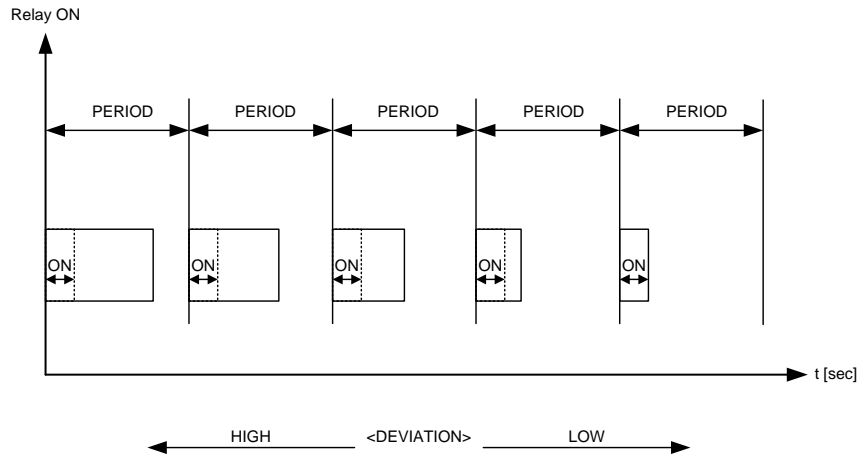

"GOV ON time" test

When adjusting the "GOV ON time", it is important to know how big a change in frequency the setting causes. If it is set too high, there is a risk that the frequency is adjusted past the deadband, which will result in unstable regulation.

In manual mode, the "GOV ON time" can be tested by enabling menu 2605. When doing so, the GOV up relay will be activated once for the duration of the "GOV ON time".



Menu 2605 is automatically reset to OFF.

Signal length

The signal length is calculated compared to the adjusted period time. In the drawing below, the effect of the proportional regulator is indicated.

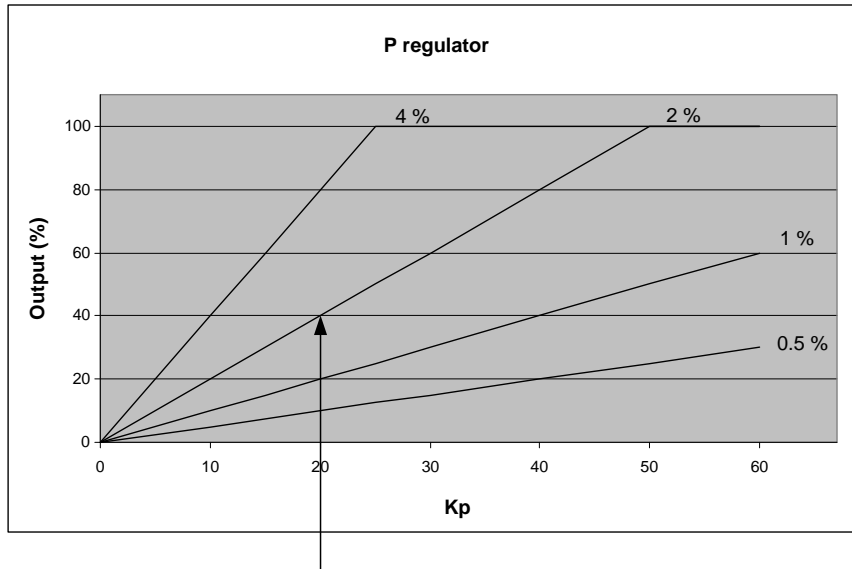

In this example we have a 2 % regulation deviation and an adjusted value of the Kp = 20. The calculated regulator value of the unit is 40 %. Now the pulse length can be calculated with a period time = 2500 ms:

$$e_{DEVIATION} / 100 * t_{PERIOD}$$

$$40 / 100 * 2500 = 1000 \text{ ms}$$

The length of the period time will never be shorter than the adjusted ON time.

Settings related to relay control

Setting	Description
2601 "GOV ON time"	The minimum length of the relay pulse. The relays will never be activated for a shorter time than the GOV ON time.
2602 "GOV period time"	The time between the beginning of two subsequent relay pulses.
2603 "GOV increase"	Relay output for GOV up command.
2604 "GOV decrease"	Relay output for GOV down command.
2605 "GOV ON time test"	Test function for the minimum pulse length (GOV ON time).

i In addition to these settings, the Kp and deadband for the relevant controllers must be adjusted as well.

7. Synchronisation

7.1 General information

Two different synchronisation principles are available, namely static and dynamic synchronisation (dynamic is selected by default). This chapter describes the principles of the synchronisation functions and the adjustment.

i In the following, the term “synchronisation” means “synchronising and closing of the synchronised breaker”.

7.2 Dynamic synchronisation

In dynamic synchronisation, the synchronising genset is running at a different speed than the generator on the busbar. This speed difference is called *slip frequency*. Typically, the synchronising genset is running with a positive slip frequency. This means that it is running with a higher speed than the generator on the busbar. The objective is to avoid a reverse power trip after the synchronisation.

The dynamic principle is illustrated below.

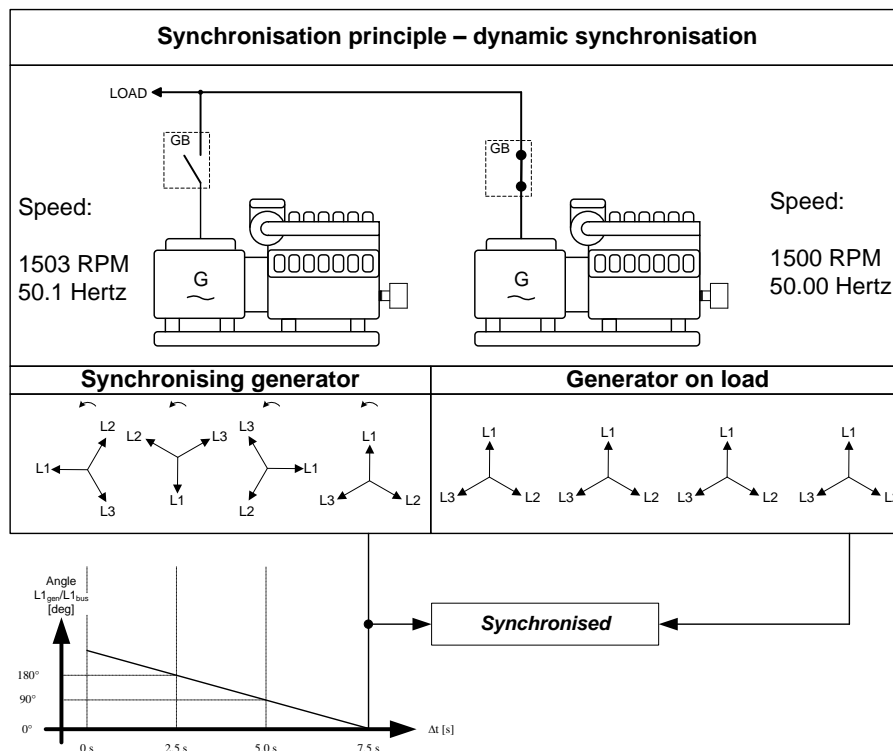

In the example above, the synchronising genset is running at 1503 RPM ~ 50.1 Hz. The generator on load is running at 1500 RPM ~ 50.0 Hz. This gives the synchronising genset a positive slip frequency of 0.1 Hz.

The intention of the synchronising is to decrease the phase angle difference between the two rotating systems. These two systems are the three-phase system of the generator and the three-phase system of the busbar. In the illustration above, phase L1 of the busbar is always pointing at 12 o'clock, whereas phase L1 of the synchronising genset is pointing in different directions due to the slip frequency.

i Of course both three-phase systems are rotating, but for illustrative purposes the vectors for the generator on load are not shown to be rotating. This is because we are only interested in the slip frequency for calculating when to release the synchronisation pulse.

When the generator is running with a positive slip frequency of 0.1 Hz compared to the busbar, the two systems will be synchronised every 10 seconds.

$$t_{sync} = \frac{1}{50.1 - 50.0} = 10 \text{ sec}$$

i Observe the chapter regarding PID controllers and the synchronising controllers.

In the illustration above, the difference in the phase angle between the synchronising set and the busbar gets smaller and will eventually be zero. Then the genset is synchronised to the busbar, and the breaker will be closed.

7.2.1 Close signal

The unit always calculates when to close the breaker to get the most accurate synchronisation. This means that the close breaker signal is actually issued before being synchronised (read L1 phases exactly at 12 o'clock).

The breaker close signal will be issued depending on the breaker closing time and the slip frequency (response time of the circuit breaker is 250 ms, and the slip frequency is 0.1 Hz):

$$\begin{aligned} \text{deg}_{close} &= 360 * t_{CB} * f_{slip} \\ \text{deg}_{close} &= 360 * 0.250 * 0.1 \\ \text{deg}_{close} &= 9 \text{ deg} \end{aligned}$$

i The synchronisation pulse is always issued, so the closing of the breaker will occur at the 12 o'clock position.

The length of the synchronisation pulse is the response time + 20 ms (**2020 Synchronisation**).

7.2.2 Load picture after synchronising

When the incoming genset has closed its breaker, it will take a portion of the load dependent on the actual position of the fuel rack. Illustration 1 below indicates that at a given *positive* slip frequency, the incoming genset will *export* power to the load. Illustration 2 below shows that at a given *negative* slip frequency, the incoming genset will *receive* power from the original genset. This phenomenon is called *reverse power*.

i To avoid nuisance trips caused by reverse power, the synchronising settings can be set up with a positive slip frequency.

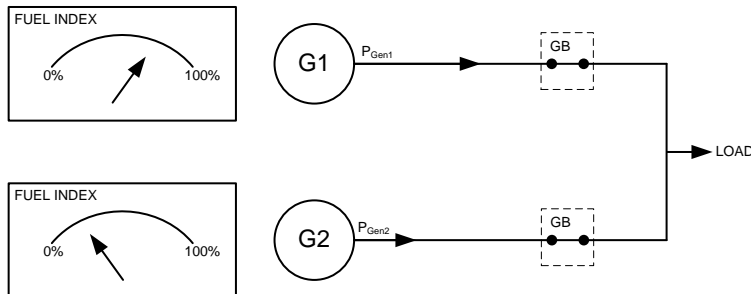

Illustration 1, POSITIVE slip frequency

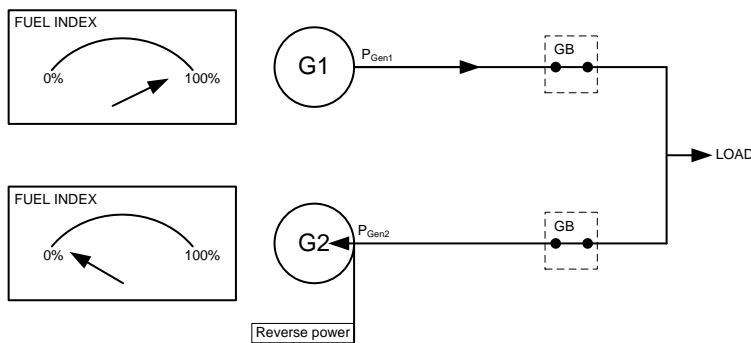

Illustration 2, NEGATIVE slip frequency

Adjustments

The dynamic synchroniser is selected in menu 2000 in the control setup and is adjusted in menu 2020 Sync.

Setting	Description	Comment
2021 f_{MAX}	Maximum slip frequency	Adjust the maximum positive slip frequency where synchronising is allowed
2022 f_{MIN}	Minimum slip frequency	Adjust the maximum negative slip frequency where synchronising is allowed
2023 U_{MAX}	Maximum voltage difference (+/- value)	The maximum allowed voltage difference between the busbar/mains and the generator
2024 t_{GB}	Generator breaker closing time	Adjust the response time of the generator breaker

It is obvious that this type of synchronisation is able to synchronise relatively fast because of the adjusted minimum and maximum slip frequencies. This actually means that when the unit is aiming to control the frequency towards its set point, synchronising can still occur as long as the frequency is within the limits of the slip frequency adjustments.

i Dynamic synchronisation is recommended where fast synchronisation is required, and where the incoming gensets are able to take load just after the breaker has been closed.

7.3 Static synchronisation

In static synchronisation, the synchronising genset is running very close to the same speed as the generator on the busbar. The aim is to let them run at exactly the same speed and with the phase angles between the three-phase system of the generator and the three-phase system of the busbar matching exactly.

i It is not recommended to use the static synchronisation principle when relay regulation outputs are used. This is due to the slower nature of the regulation with relay outputs.

The static principle is illustrated below.

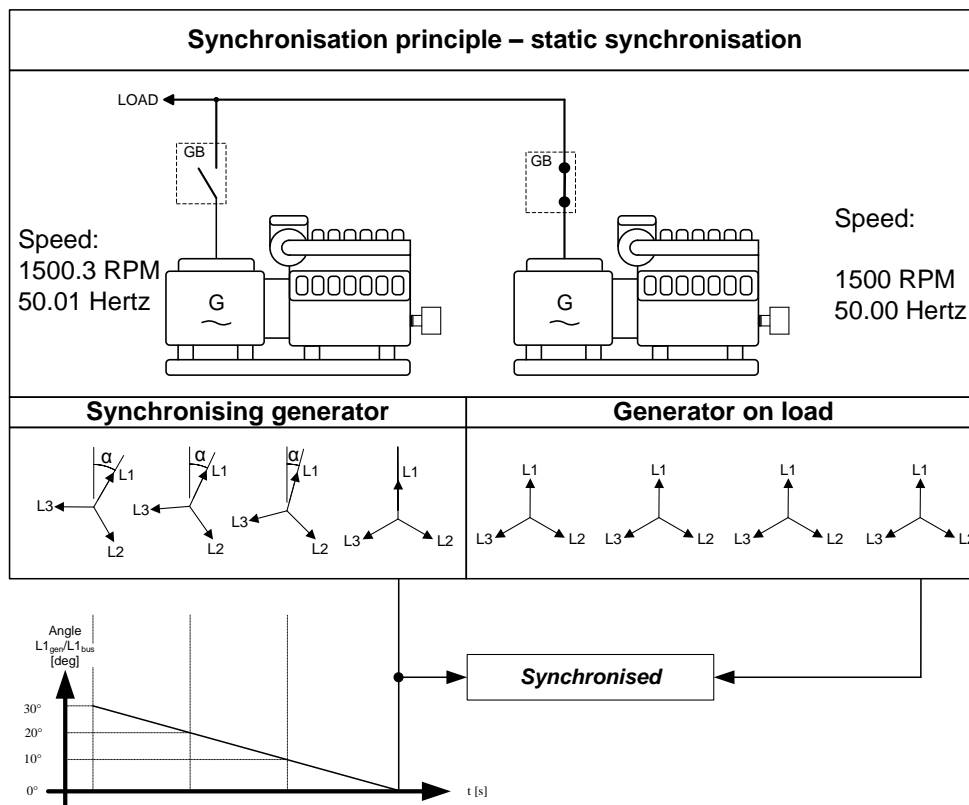

7.3.1 Phase controller

When the static synchronisation is used and the synchronising is activated, the frequency controller will bring the genset frequency towards the busbar frequency. When the genset frequency is within 50 mHz of the busbar frequency, the phase controller takes over. This controller uses the angle difference between the generator system and the busbar system as the controlling parameter.

This is illustrated in the example above where the phase controller brings the phase angle from 30 deg. to 0 deg.

Close signal

The close signal will be issued when phase L1 of the synchronising generator is close to the 12 o'clock position, compared to the busbar which is also in 12 o'clock position. It is not relevant to use the response time of the circuit breaker when using static synchronisation, because the slip frequency is either very small or non-existing.

To get a faster synchronisation, a “close window” can be adjusted. The close signal can be issued when the phase angle UGENL1-UBBL1 is within the adjusted set point. The range is +/-0.1 to 20.0 deg. This is illustrated in the drawing below.

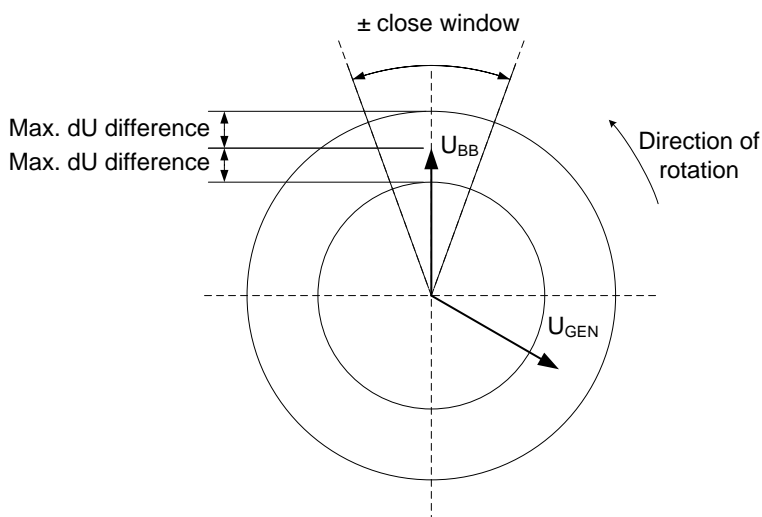

The synchronisation pulse is sent according to the settings in menu 2030 Sync.

Load picture after synchronisation

The synchronised genset will not be exposed to an immediate load after the breaker closure if the maximum df setting is adjusted to a low value. Since the fuel rack position almost exactly equals what is required to run at the busbar frequency, no load jump will occur.

If the maximum df setting is adjusted to a high value, the observations in the section “Dynamic synchronisation” must be observed.

 Static synchronisation is recommended where a slip frequency is not accepted, for example if several gensets synchronise to a busbar with no load groups connected.

Static synchronisation types

It is possible to select between three different functions of the static synchronisation, dependent on application requirements.

Breaker sync.:	Normal functionality; a breaker ON pulse is activated when the requirements for synchronisation are fulfilled.
Sync. check:	This function makes the unit act solely as a check synchroniser, for example, no regulation of frequency and/or voltage will be performed. A constant GB ON command is activated as long as the requirements for synchronisation are fulfilled. The “GB close failure” alarm is not active when this function is selected. This function does not require any hardware for regulation.
Infinite sync.:	The generator is kept in synchronism with the busbar, and no breaker command is used.

Settings

The following settings must be adjusted, if the static synchronisation is selected:

Setting	Description	Comment
2031 Maximum df	The maximum allowed frequency difference between the busbar/mains and the generator	+/- value
2032 Maximum dU	The maximum allowed voltage difference between the busbar/mains and the generator	+/- value, related to the nominal generator voltage
2033 Closing window	The size of the window where the synchronisation pulse can be released	+/- value
2034 Static sync.	Minimum time inside the phase window before sending a close command	
2035 Static type	Selection of synchronisation type	See separate description

7.4 Synchronising controller

A dedicated controller is used whenever synchronising is activated. After a successful synchronisation, the frequency synchronisation controller is deactivated and the relevant controller is activated, for example the load sharing controller.



The unit provides separate settings for dynamic, static and asynchronous synchronisation which are used according to the table below.

Sync. type/Interface type	Relay	Analogue/PWM
Dynamic	2050 f sync ctrl rel	2040 f sync. control
Static	2050 f sync ctrl rel 2070 Phase ctrl rel.	2040 f sync. control 2060 Phase control
Asynchronous	2090 Async. sync.	2080 RPM sync. ctrl

7.5 Synchronising vector mismatch alarm

During synchronisation, the calculation and synchronisation check is based on BB-L1 and DG-L1 measurements.

The “vector mismatch” alarm (menu 2190) will appear if a phase angle difference between BB L2/L3 and Gen L2/L3 is above 20 deg.

-  The vector mismatch alarm will by default block the GB close sequence, but the fail class can be configured in parameter 2196.
-  If the phase sequence does not match (for example, cable mounted incorrectly), a “Phase seq. error” will appear and block the GB close sequence.

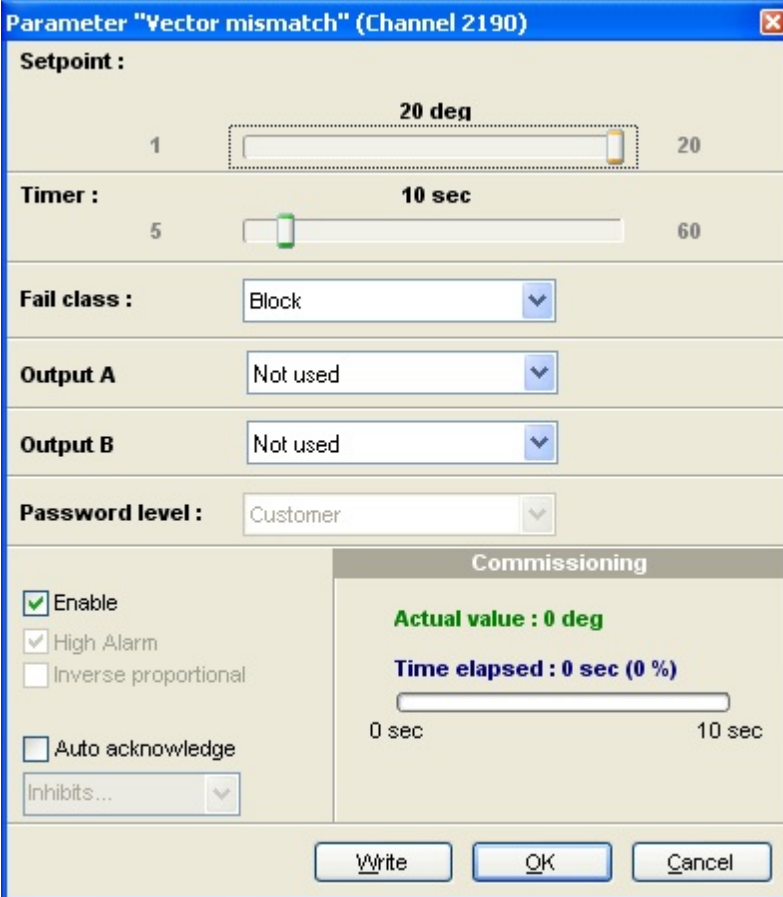

The screenshot shows the configuration window for parameter 2190, titled "Parameter 'vector mismatch' (Channel 2190)". The window is divided into several sections:

- Setpoint:** A slider control is set to 20 deg, with a range from 1 to 20.
- Timer:** A slider control is set to 10 sec, with a range from 5 to 60.
- Fail class:** A dropdown menu is set to "Block".
- Output A:** A dropdown menu is set to "Not used".
- Output B:** A dropdown menu is set to "Not used".
- Password level:** A dropdown menu is set to "Customer".
- Commissioning:** A sub-section showing "Actual value : 0 deg" and "Time elapsed : 0 sec (0 %)" with a corresponding progress bar.
- Options:** A list of checkboxes: "Enable" (checked), "High Alarm" (checked), "Inverse proportional" (unchecked), and "Auto acknowledge" (unchecked). There is also an "Inhibits..." dropdown menu.
- Buttons:** "Write", "OK", and "Cancel" buttons are located at the bottom.

-  The vector mismatch timer should be set to a value lower than the GB sync. failure timer (parameter 2131).

7.6 Asynchronous synchronisation

 This function requires option M4.

Closing of a breaker for an asynchronous generator (also called induction generator) can be selected in menu 6361 where the selection of generator type is made. When the generator type is set to “asynchronous”, the closing of the breaker is based on the MPU signal only.

Running feedback

The MPU input must be used as primary running feedback when the asynchronous generator is used. The start and operation of the generator requires that the nominal speed is adjusted (for example, 1500 or 1800 RPM).

Breaker closing

When the genset is running, the GB can be closed in local or remote mode. During the GB close sequence, the speed set point will be:

$$\text{RPM set point} = \text{RPM nom.} + (\text{RPM SLIP min.} + \text{RPM SLIP max.})/2.$$

The acceptable slip frequency is set in menu 2010.

When the speed set point is reached, the close GB signal is issued. After the GB has been closed and running has been detected on the voltage and frequency, the regulation mode will change according to the regulation mode inputs.

 After the GB has been closed, the control of the “asynchronous” generator is the same as for the “synchronous” type.

7.7 Blackout closing

If required, the unit can be enabled to close the GB on a dead bus. This can be handled in one of the following ways:

1. Enable GB black closing in menu 2113
2. Use the digital input function “Enable GB black close”

Setting of 2013 “Sync. blackout”	“Enable GB black close” input NOT defined* (default)	“Enable GB black close” input defined*
OFF (default)	The unit is not able to close the GB onto a dead busbar	Closing of the GB onto a dead busbar is controlled by the digital input alone
ON	The unit will close the GB onto a dead busbar	

*Defined means that the function has been dedicated to a specific input by means of the input/output configuration in the PC utility software.

As shown in the table above, the digital input function “Enable GB black close” will overrule the setting of menu 2113.

Requirements for blackout closing of the breaker:

Condition	Description
Blackout detected	Blackout is detected when the voltage on the busbar is below 30 % of nominal busbar voltage
Generator voltage and frequency OK	To initiate the black closing, the generator voltage and frequency must be inside the limits set in menus 2111 and 2112



Using this function involves a risk of closing breakers out of synchronism. It is therefore required to take external precautions to avoid simultaneous closing of two or more breakers onto a dead bus.

7.8 Separate synchronising relay

When the unit gives the synchronising command, the relays on terminal 17/18/19 (generator breaker) will activate, and the breaker must close when this relay output is activated.

This default function can be modified using a digital input and extra relay outputs, dependent on the required function. The relay selection is made in menu 2240, and the input is selected in the input settings in the utility software.

The table below describes the possibilities.

Relay/ Input	Relay selected Two relays used	Relay not selected One relay used
Not used	<p>Synchronising: The breaker ON relay and the sync. relay activate at the same time when synchronising is OK.</p> <p>Blackout closing: The breaker ON relay and the sync. relay activate at the same time when the voltage and frequency are OK.</p>	<p>Synchronising: The breaker ON relay activates when synchronising is OK.</p> <p>Blackout closing: The breaker ON relay activates when the voltage and frequency are OK.</p> <p>DEFAULT selection</p>
Low	<p>Synchronising: Not possible.</p> <p>Blackout closing: The breaker ON relay and the sync. relay activate at the same time when the voltage and frequency are OK.</p>	<p>Synchronising: Not possible.</p> <p>Blackout closing: The breaker ON relay activates when the voltage and frequency are OK.</p>
High	<p>Synchronising: The relays will activate in two steps when the synchronising is selected:</p> <ol style="list-style-type: none"> 1. Breaker ON relay activates. 2. When synchronised, the sync. relay activates. <p>See note below!</p> <p>Blackout closing: The breaker ON relay and the sync. relay activate at the same time when the voltage and frequency are OK.</p>	<p>Synchronising: Not possible.</p> <p>Blackout closing: The breaker ON relay activates when the voltage and frequency are OK.</p>



When the two relays are used together with the separate sync. input, notice that the breaker ON relay will be activated as soon as the GB ON/synchronising sequence is activated. Take care that the GB ON relay cannot close the breaker before the sync. signal is issued by the sync. relay.



The selected relay for this function must have the 'limit' function. This is adjusted in the I/O setup.

7.9 Inhibit conditions before synchronising mains breaker

This function is used to inhibit the synchronising of the mains breaker after blackout. After blackout, the timer in menu 2291 ("Delay activate recovery 2") will start to run, and if the mains voltage and frequency are inside the limits (2281/2282/2283/2284) before the timer runs out, the short interruption timer (menu 2292 "Recovery del. 1") will be started. When the timer has run out, the synchronising of the MB will start.

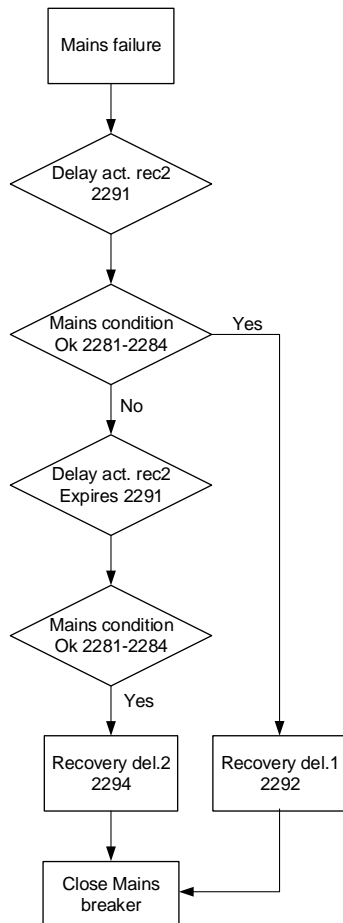

If the "Delay activate recovery 2" timer runs out, the long interruption timer (menu 2294 "Recovery del. 2") will start to run.

Examples:

Recovery timer 1 (short interruption timer)

Menu 2291 = 3 s

Menu 2292 = 5 s

That means: if the short interruption timer is set to ≤ 3 s, and the grid is back and voltage and frequency are inside the acceptable range stated above, then after 5 s the MB can be closed.

Recovery timer 2 (long interruption timer)

Menu 2291 = 3 s

Menu 2294 = 60 s

The long interruption timer will allow the MB to reconnect as soon as the mains voltage and frequency have been uninterrupted within the timer setting in menu 2294 ("Recovery del. 2"). Then the MB can be closed.



The inhibit parameters for synchronising the MB are disabled by default.