



# OPERATOR'S MANUAL



## TDU 107 Touch Display Unit



## 1. Introduction

<b>1.1 About the Operator's manual</b> .....	<b>4</b>
1.1.1 Intended users of the Operator's manual.....	4
1.1.2 Software versions.....	4
1.1.3 List of technical documentation.....	4
1.1.4 Technical support.....	4
1.1.5 Symbols for hazard statements.....	5
1.1.6 Symbols for notes.....	5
<b>1.2 Warnings and safety</b> .....	<b>6</b>
<b>1.3 Legal information</b> .....	<b>6</b>
1.3.1 Trademarks.....	6
1.3.2 Third party equipment.....	6
1.3.3 Disclaimer.....	7
1.3.4 Copyright.....	7









## 2. Overview of the unit





<b>2.1 Introduction</b> .....	<b>8</b>
<b>2.2 Layout</b> .....	<b>9</b>
2.2.1 Unit.....	9
2.2.2 Status bar.....	10
2.2.3 Core connections.....	11
2.2.4 Extended connections.....	11

## 3. Operating the system

<b>3.1 Menus</b> .....	<b>13</b>
3.1.1 Return (back) navigation.....	13
<b>3.2  Keyboards</b> .....	<b>14</b>
3.2.1 Text keyboard.....	14
3.2.2 Value keyboard.....	15
<b>3.3  Software update using USB</b> .....	<b>16</b>
3.3.1 Before you begin.....	16
3.3.2 Download and update software.....	16

## 4. Features

<b>4.1  Home : Control panel</b> .....	<b>17</b>
4.1.1 Change instrument.....	18
4.1.2 Instrument property.....	19
<b>4.2  Supervision</b> .....	<b>20</b>
<b>4.3  Controller settings</b> .....	<b>21</b>
4.3.1  Edit settings.....	22
4.3.2  Filter groups.....	23
<b>4.4  Alarms</b> .....	<b>24</b>
4.4.1 Alarms popup.....	25
<b>4.5  Logs</b> .....	<b>26</b>
<b>4.6  Exhaust After-Treatment Dashboard (Tier4)</b> .....	<b>27</b>
<b>4.7  Alternator curve</b> .....	<b>28</b>

<b>4.8</b>  <b>Additional Operator Panel (AOP)</b> .....	<b>29</b>
<b>4.9</b>  <b>Language</b> .....	<b>30</b>
<b>4.10</b>  <b>User permissions</b> .....	<b>31</b>
4.10.1 Password levels.....	31
4.10.2 User permissions.....	31
<b>4.11</b>  <b>Display Config</b> .....	<b>32</b>
4.11.1 More settings.....	33
<b>4.12</b>  <b>Language Mgt.</b> .....	<b>34</b>
<b>4.13 Language translations</b> .....	<b>35</b>
4.13.1 Introduction.....	35
4.13.2 Before you begin.....	35
4.13.3 Create or edit language translation.....	36
<b>4.14 Export or import settings</b> .....	<b>37</b>
4.14.1 Introduction.....	37
4.14.2 Before you begin.....	37
4.14.3 Export or import configuration file.....	37
<b>4.15 Access lock</b> .....	<b>39</b>
<b>5. End-of-life</b>	
<b>5.1 Disposal of waste electrical and electronic equipment</b> .....	<b>40</b>

# 1. Introduction

## 1.1 About the Operator's manual

### 1.1.1 Intended users of the Operator's manual

This is the operator's manual for DEIF's Touch Display Unit, TDU 107 controlling the AGC-4 Mk II or AGC-4 genset or mains controller.

The manual is for the operator who uses the TDU 107. The manual includes an introduction to the unit, basic operator tasks, alarms, logs, and more advanced operator tasks.

**NOTE** The manual does not describe self-explanatory functions that the operator can easily explore. For example, the *Service* menu and its *Live Data* and *Service Timers* pages.

### 1.1.2 Software versions

The information in this document corresponds to the following software versions.

**Table 1.1** Software versions

Software	Details	Version
AGC-4 Mk II	Controller application	6.00.x or later
AGC-4	Controller application	4.76.x or later
<ul style="list-style-type: none"><li>• TDU 107 Core</li><li>• TDU 107 Extended</li></ul>	Display unit application	1.3.7.x or later

### 1.1.3 List of technical documentation

Document	Contents
Data sheet	<ul style="list-style-type: none"><li>• System description</li><li>• Technical specifications</li><li>• Ordering information</li></ul>
Installation instructions	<ul style="list-style-type: none"><li>• Mounting</li><li>• Default wiring</li></ul>
Operator's manual	<ul style="list-style-type: none"><li>• Operating the unit</li><li>• Alarms and log</li></ul>

### 1.1.4 Technical support

You can read about service and support options on the DEIF website, <http://www.deif.com>. You can also find contact details on the DEIF website.

You have the following options if you need technical support:

- Technical documentation: Download all the product technical documentation from the DEIF website: <http://www.deif.com/documentation>
- Support: DEIF offers 24-hour support. See <http://www.deif.com/support> for contact details. There may be a DEIF subsidiary located near you. See <http://www.deif.com/support/local-office>

## 1.1.5 Symbols for hazard statements



### DANGER!



**This highlights dangerous situations.**

If the guidelines are not followed, these situations will result in death, serious personal injury, and equipment damage or destruction.



### WARNING



**This highlights potentially dangerous situations.**

If the guidelines are not followed, these situations could result in death, serious personal injury, and equipment damage or destruction.



### CAUTION



**This highlights low level risk situation.**

If the guidelines are not followed, these situations could result in minor or moderate injury.

### NOTICE

**This highlights an important notice**

Make sure to read this information.

## 1.1.6 Symbols for notes



### More information

This highlights where to find more information.

**NOTE** \* This highlights a referenced note.



### Example heading

This highlights an example.



This highlights tapping or pressing the screen area.



This highlights pressing and holding the screen area for an amount of seconds.



This highlights swiping the screen area, up or down.



This highlights swiping the screen area, left or right.

## 1.2 Warnings and safety



### DANGER!

#### Hazardous live currents and voltages



Risk of electrical shock

Switchboard access must only be carried out by authorised personnel who understand the risks involved in working with electrical equipment. Do not touch any terminals, especially the AGC AC measurement inputs and the relay terminals. Touching the terminals could lead to injury or death.



### WARNING

#### Possible automatic genset starts



Risk of personal injury

The power management system automatically starts gensets when more power is needed. It can be difficult for an inexperienced operator to predict which gensets will start. In addition, gensets can be started remotely (for example, by using an Ethernet connection, or a digital input). To avoid personal injury, the genset design, the layout, and maintenance procedures must take this into account.

### NOTICE

#### Manually overriding alarm actions

Risk of damage to genset or equipment

Manually overriding alarm actions could cause damage to the genset or equipment. Do not use manual control to override the alarm action of an active alarm.

### NOTICE

#### Manual control

Limited automatic protection actions

Under Manual control, the operator controls and operates the equipment from the switchboard. The controller does not; respond to blackouts, provide any power management, accept operator commands, and/or prevent any manual operator actions. The switchboard design must therefore ensure that the system is sufficiently protected when the controller is under Manual control.

## 1.3 Legal information

### 1.3.1 Trademarks

DEIF is a trademark of DEIF A/S.

All trademarks are the properties of their respective owners.

### 1.3.2 Third party equipment

DEIF takes no responsibility for the installation or operation of any third party equipment, including the **genset**. Contact the **genset company** if you have any doubt about how to install or operate the genset.

### **1.3.3 Disclaimer**

DEIF A/S reserves the right to change any of the contents of this document without prior notice.

The English version of this document always contains the most recent and up-to-date information about the product. DEIF does not take responsibility for the accuracy of translations, and translations might not be updated at the same time as the English document. If there is a discrepancy, the English version prevails.

### **1.3.4 Copyright**

© Copyright DEIF A/S. All rights reserved.

## 2. Overview of the unit

### 2.1 Introduction

#### NOTICE

##### Software features described

This manual applies to both **TDU 107 Core** and **TDU 107 Extended**. The software features are the same.

The Touch Display Unit, TDU 107, is a touch screen solution for controlling an AGC-4 Mk II or AGC-4 genset or mains controller using the Ethernet port. \*

**Figure 2.1** Example connection

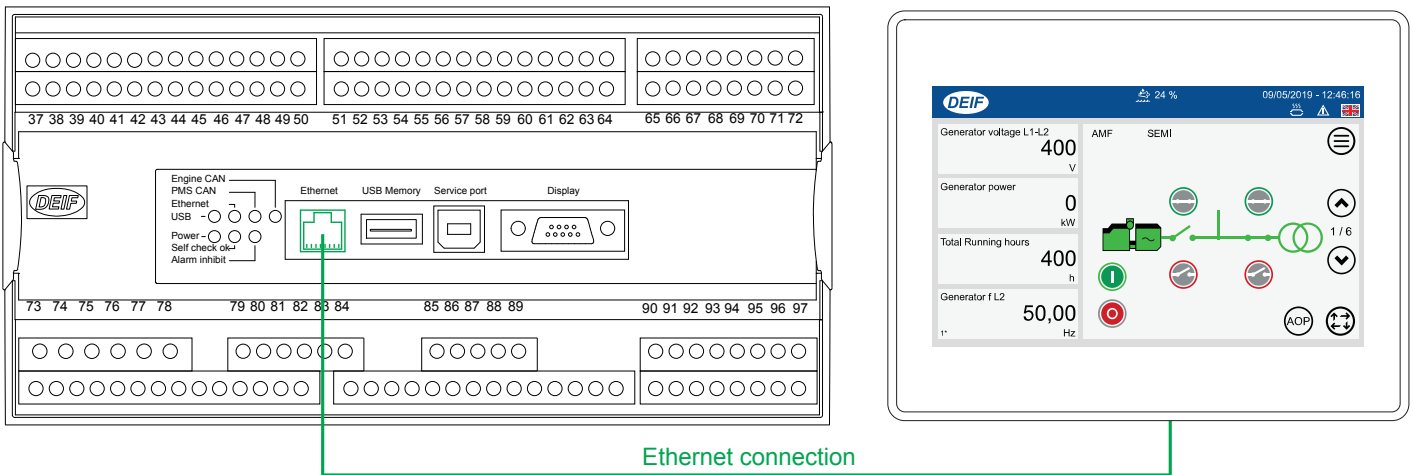

**NOTE** \* The AGC-4 requires the Ethernet option N for connection.

The display gives user-friendly touch screen control, visualisation, and graphic displays from the AGC.

Simply operate the controller and access any feature by touching the screen.

#### NOTICE

##### Bridged Ethernet ports

The TDU 107 Extended has two Ethernet that are bridged, ETH0 and ETH1.



## 2.2 Layout

### 2.2.1 Unit

Figure 2.2 TDU 107 layout

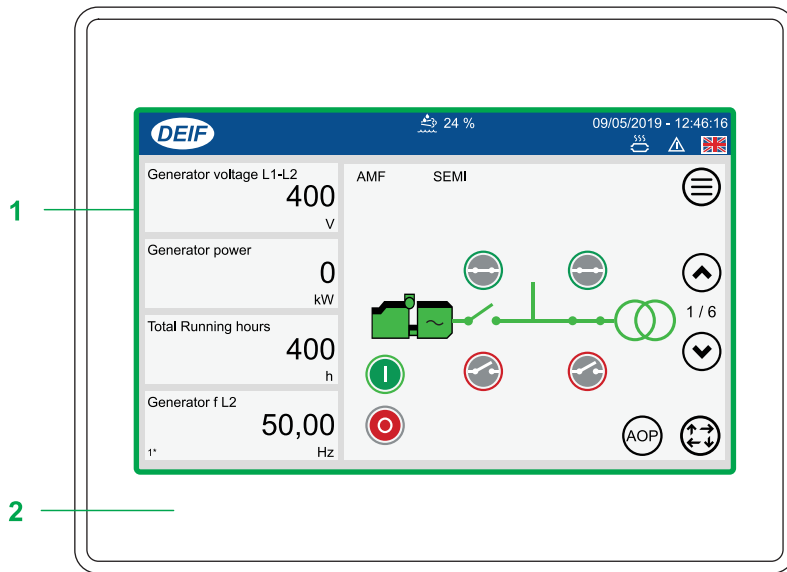

No.	Item	Notes
1	Touch screen area	Operate the controller by touching the screen.
2	Frame	

## 2.2.2 Status bar

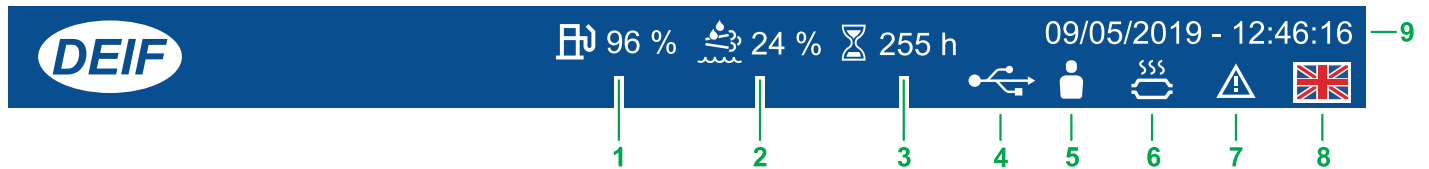

No.	Item	Use	Notes
1	Fuel level *	-	Shows the fuel level.
2	Diesel Exhaust Fluid (DEF) percentage **	-	Shows the DEF percentage.
3	Running hours ***	-	Shows the total of running hours.
4	USB drive	-	Shows a USB drive was detected.
			Prompts to remove the USB drive safely.
5	User logged on		Shows a user is logged on.
			Displays prompt to logout.
6	Exhaust After-Treatment Dashboard		Opens Exhaust After-Treatment Dashboard (Shortcut). *
7	Alarm(s)		Opens Alarms (Shortcut).
8	Language		Opens Language (Shortcut).
9	Date and Time	-	Shows the controller Date and Time.

**NOTE** \* Only shown if the fuel level is configured with a multi-input. Use either multi-input 102 parameter 10980, multi-input 105 parameter 10990, or multi-input 108 parameter 11000 with **RMI fuel level**.

**NOTE** \*\* Only shown if the Engine communication is configured.

**NOTE** \*\*\* Only shown for genset controllers and not on mains controllers.

## 2.2.3 Core connections

### TDU 107 Core connections

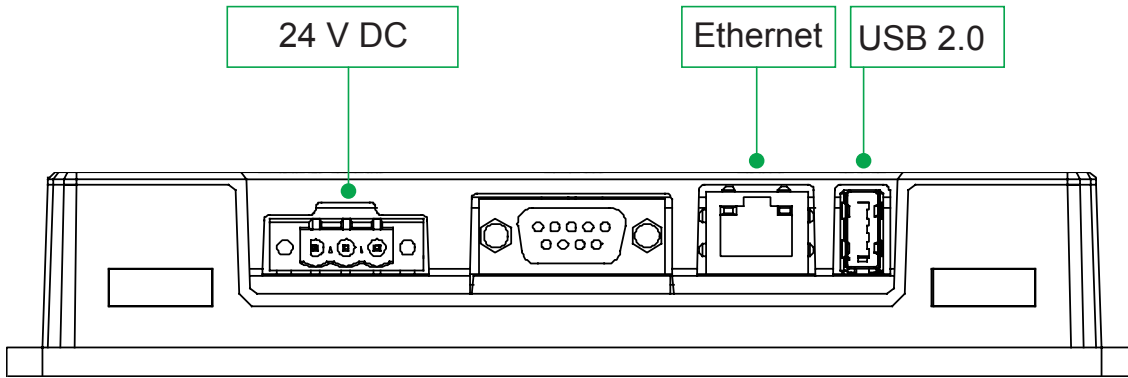

The TDU 107 Core can be connected to the controller directly or using a switch. Use a USB type A-B cable to connect a service computer to the AGC if the TDU Core is connected directly to the controller.

### Connecting a controller to TDU 107 Core

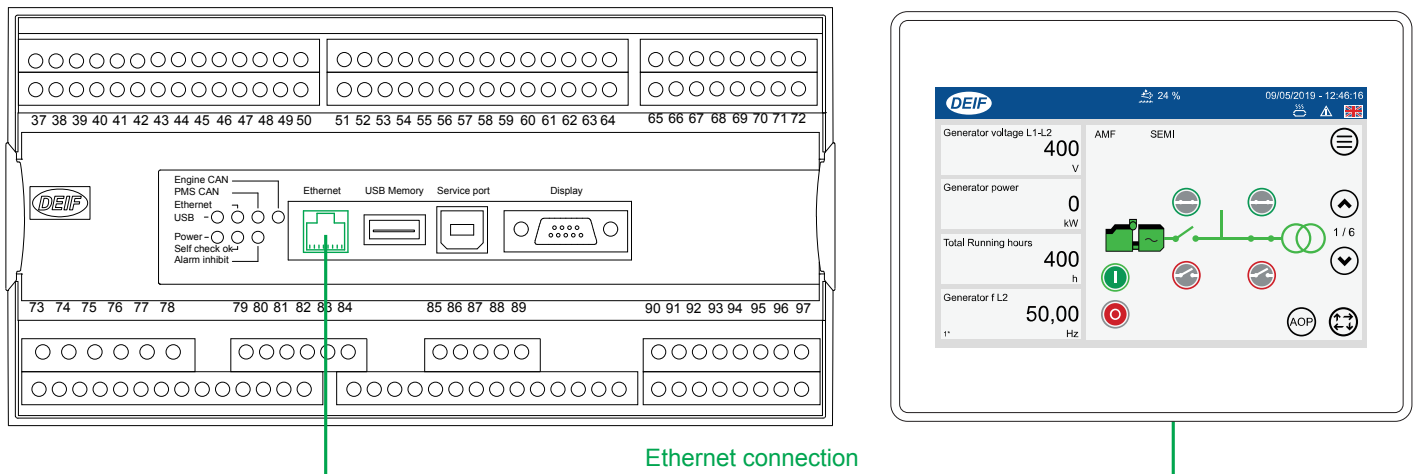

## 2.2.4 Extended connections

### TDU 107 Extended connections

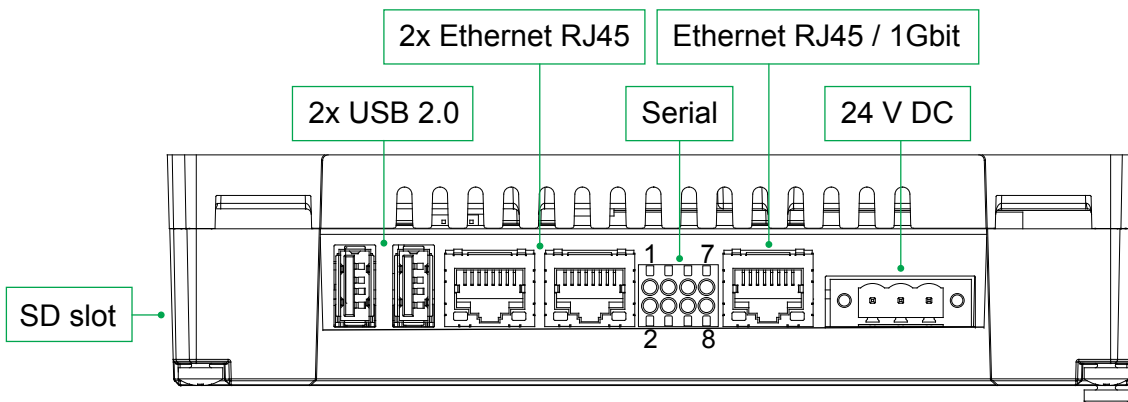

Connections that place a high data transfer load on the controller (for example, a SCADA system) should be connected to the controller through a switch.

**Recommended wiring to connect a SCADA system to the controller (AGC-4\* example)**

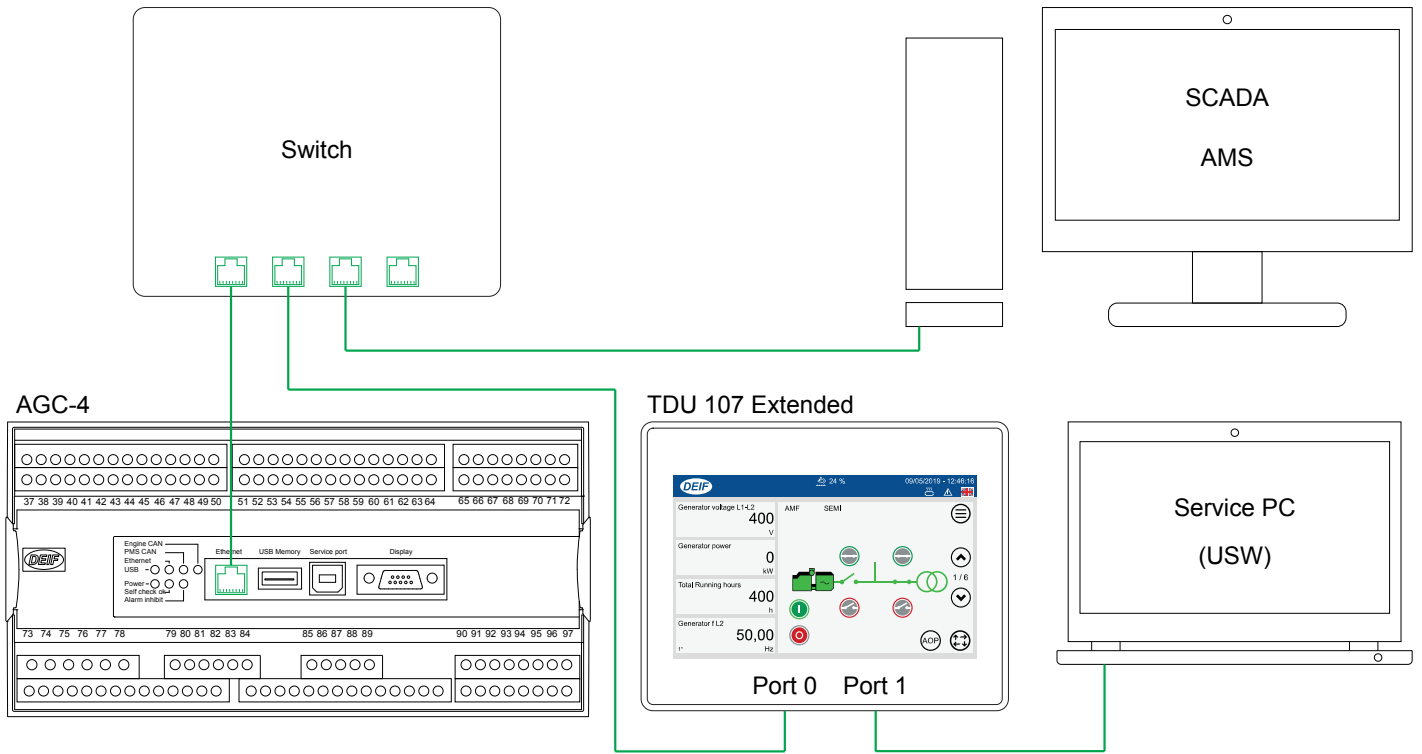

In system configurations without a high data transfer connection it is possible to connect the TDU 107 Extended version directly to the controller and connect a service PC to the TDU 107.

**AGC-4\* example wiring for a system configuration without a high data transfer connection**

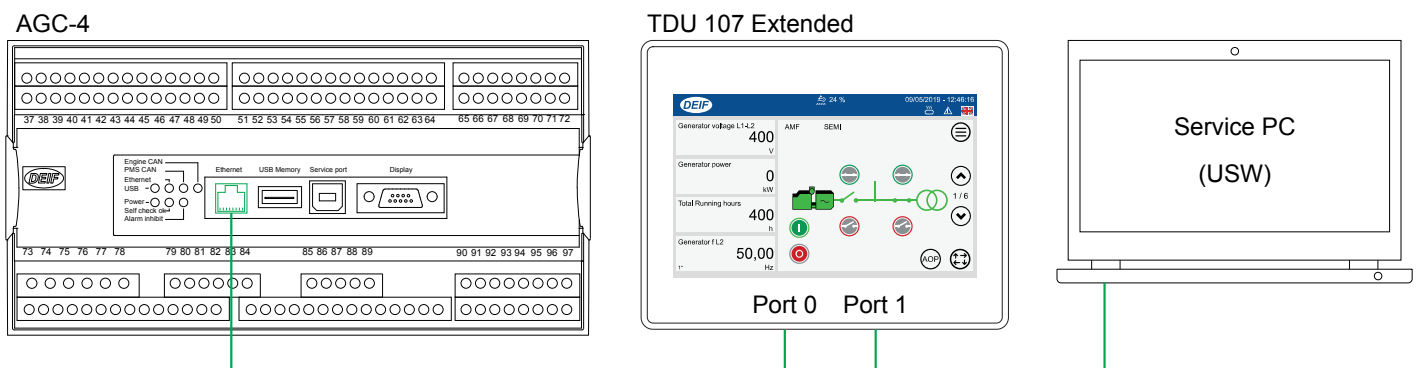



**NOTE** \* The wiring is the same for AGC-4 Mk II.

## 3. Operating the system

### 3.1 Menus

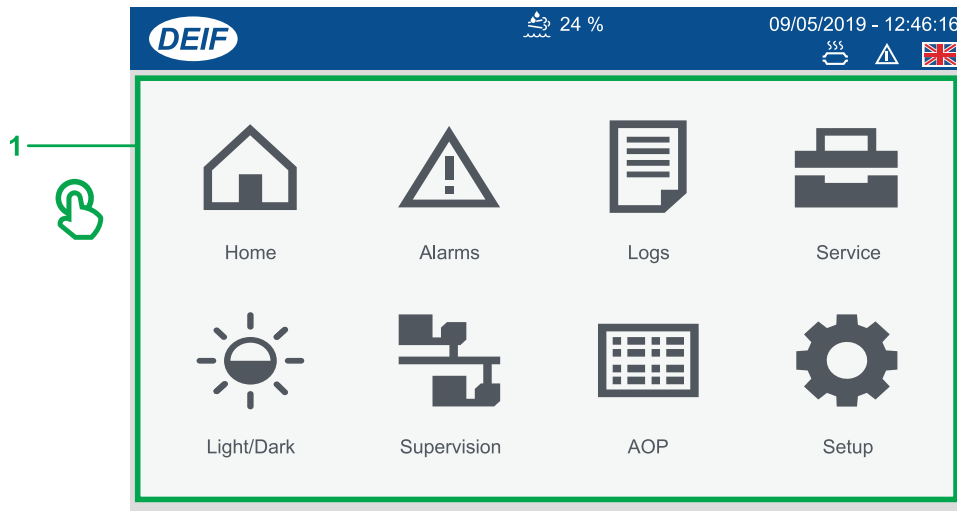
The menu pages give you access to the features and to other menus.



No.	Item	Use	Notes
1	Features		Shows available features or other menus.
			Selects feature or menu.

#### 3.1.1 Return (back) navigation

Some displays allow you to go back to the previous feature or menu.









Use **Return**  to return to a previous menu or display.

## 3.2 Keyboards

### 3.2.1 Text keyboard

You enter text information on the display by using the virtual text keyboard.



No.	Item	Use	Notes
1	Text	-	Shows the text you are entering.
2	Keyboard		Selects letters, numbers, or symbols.
3	Cursor		 Moves the cursor to the left.  Moves the cursor to the right.
4	Enter		Confirms the text entered.
5	Backspace		Deletes the last character.
6	Cancel		 Cancels the changes.

### 3.2.2 Value keyboard

You enter number values on the display by using the virtual value keyboard.

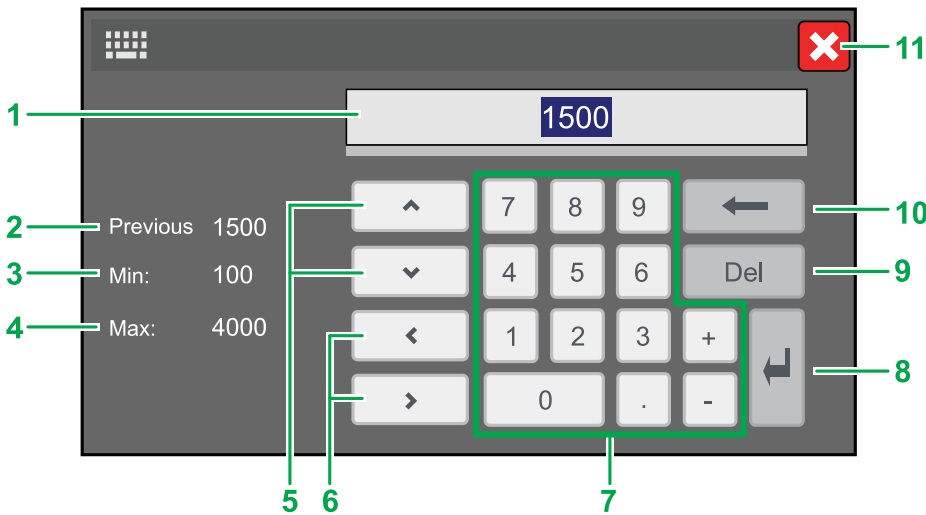

No.	Item	Use	Notes
1	Value	-	Shows the value you are entering.
2	Previous value	-	Shows the value before any changes.
3	Minimum value	-	Shows the minimum value you can enter.
4	Maximum value	-	Shows the maximum value you can enter.
5	Increase / Decrease		Allows you to increase or decrease the value.
			Increase value.
6	Cursor		Moves the cursor to the left.
			Moves the cursor to the right.
7	Keypad		Selects number or symbol.
8	Enter		Confirms the value entered.
9	Forward delete		Deletes the next character.
10	Backspace		Deletes the last character.
11	Cancel		Cancels the changes.

## 3.3 Software update using USB

### 3.3.1 Before you begin

You can update your TDU 107 with the latest software version by using the USB port.



#### More information

See **Core connections** or **Extended connections** for more information about the location of the USB port on the display.

To update your TDU 107, you need the following:

#### Required tools

- USB drive (FAT32)
  - To import/export the file(s) to your PC and TDU 107.
  - Must be formatted for FAT32 file system to be recognised by the TDU 107.
- PC
  - To download the software package file.
  - To copy the software package file to the USB drive.

### 3.3.2 Download and update software

1. Visit the DEIF homepage <https://www.deif.com/products/tdu-107#software> to download the latest version.
  - Software is available for both **TDU 107 Core** and **TDU 107 Extended**.
  - Download the software for your version of the TDU 107.
2. Follow the instructions in the DEIF email to complete the software download.
3. The software package is provided as a zipped archive (.zip) file. Do not unzip this file.
4. If the old software in the TDU has a version number lower than 1.3.7, rename the zip file "UpdatePackage..." (**U** and **P** must be capital letters).
  - For example, if the zip file is "updatepackage\_1-3-7-0\_pdb7310.zip", rename it "UpdatePackage\_1-3-7-0\_pdb7310.zip".
5. Copy the zip file to your USB drive.
6. Insert the USB drive in the USB port on your TDU 107.
7. The TDU 107 detects the update package. Select *Confirm* to start the update.
8. Select *Confirm* to restart the TDU 107.
9. After the TDU 107 restarts, select *Startup sequence*.
10. Select *Install*.
11. Double tap the folder *Mnt*, then double tap the folder *usbmemory*.
12. Select the update package and select *OK*.
13. The TDU 107 installs the update.
14. To complete the configuration, select *Continue*.
15. Select *Done*, then select *Start HMI*.
16. The TDU 107 restarts.
17. Remove the USB drive from the TDU 107. The TDU 107 is now updated and ready to use.



## 4. Features

### 4.1 Home : Control panel

Operation: Mode change, open/close breakers, and start/stop GENSET. Shows selected measurements.

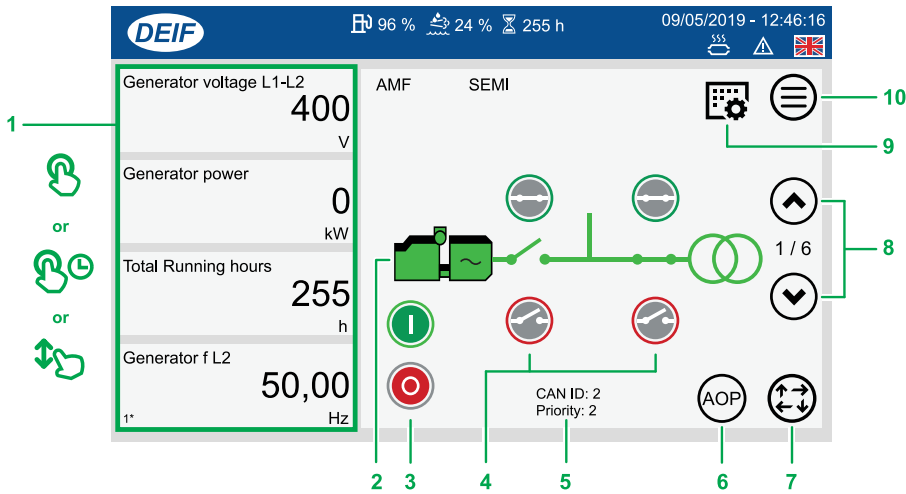

No.	Item	Use	Notes
1	Instrument values		Changes instrument shown.  Hold for > 3 seconds to configure instrument properties.
			Scrolls up or down instrument pages.
2	Engine information		Opens the engine information page.
3	Generator control		Starts generator.  Stops generator.
4	Breaker control		Closes breaker.  Opens breaker.
5	CAN ID / Priority	-	Shows the CAN ID and the priority number in power management applications. Only shown in power management applications and not in a single genset operation.
6	AOP *		Opens Additional Operator Panel (Shortcut *).
7	Mode change		Manual mode.  SEMI mode.
			AUTO mode.  TEST mode.
8	Scroll page		Scrolls up.  Scrolls down.
9	Parameters *		Opens Controller settings (Shortcut *).
10	Menu		Opens the menu page.



#### More information

\* See **Display config** for how to add shortcuts for Parameters or AOP.

## 4.1.1 Change instrument

Changes the displayed instrument value shown on the Control panel page.

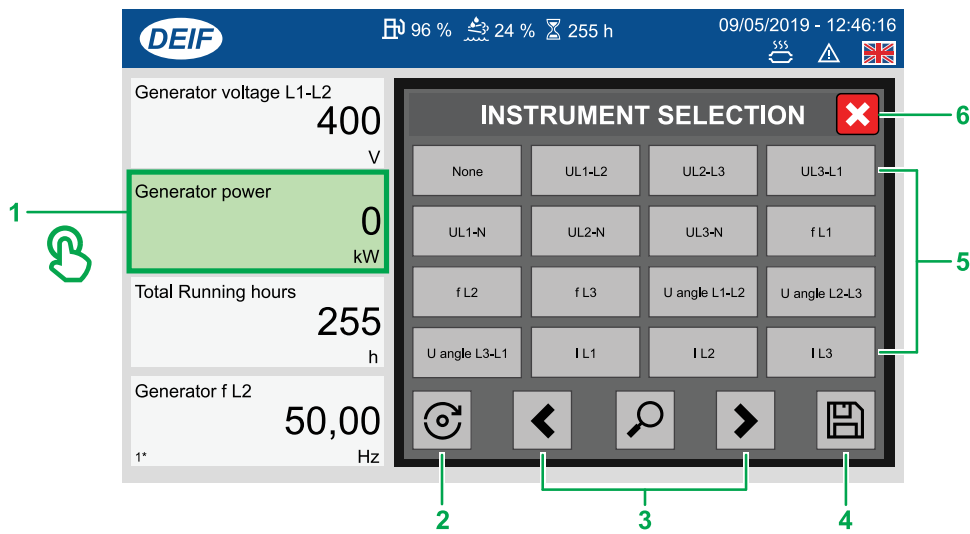

No.	Item	Use	Notes
1	Instrument value to change		Selects instrument to change.
2	Refresh		Refreshes the list of values.
3	Scroll and search		Scrolls page left.  Scrolls page right. Searches for values.
4	Save		Saves the change.
5	Instrument values		Selects the value.
6	Cancel		Cancels the change.

## 4.1.2 Instrument property

Configures the displayed instrument properties: unit, decimals, offset, and multiply.

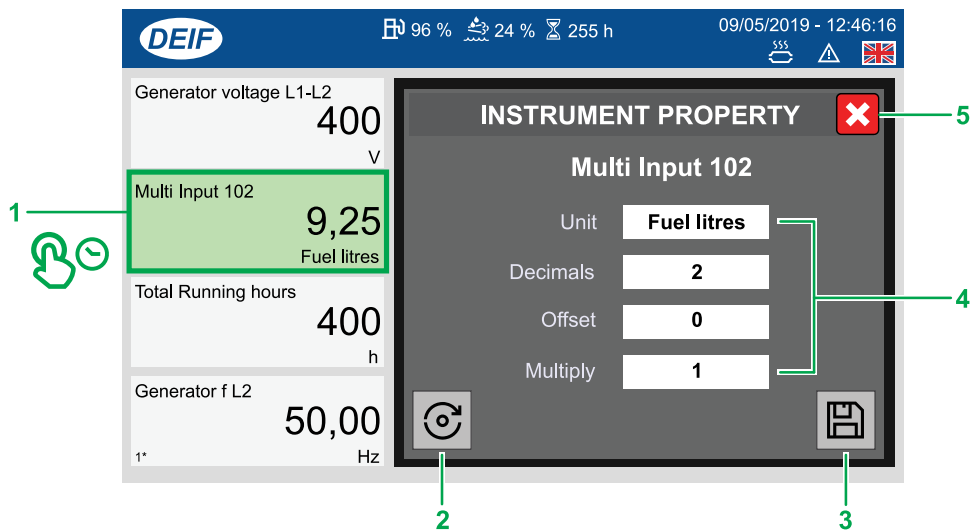



No.	Item	Use	Notes
1	Instrument value to change		Selects instrument to change.
2	Factory setting		Returns the properties back to the factory default values.
3	Save		Saves the change.
4	Instrument properties		Configures the different instrument properties.
5	Cancel		Cancels the change.

## 4.2 Supervision

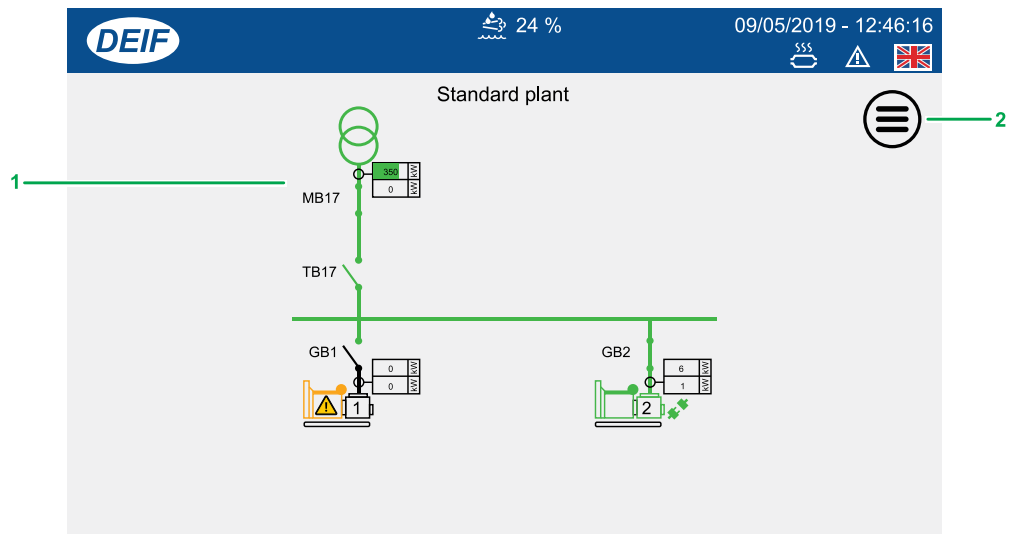
Views the state of the system in real-time. \*











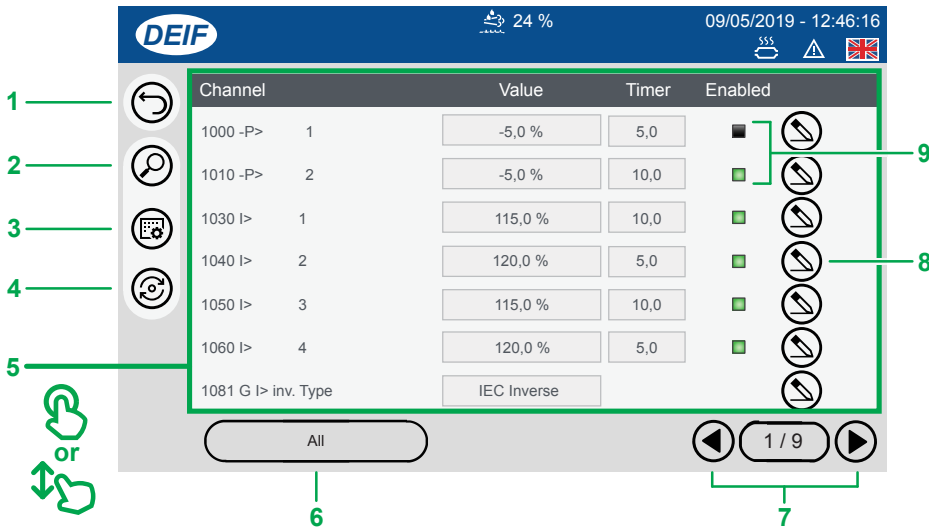









No.	Item	Use	Notes
1	Live system overview	-	Shows the system state. *
2	Menu		 Opens the menu page.

**NOTE** \* Actual system shown depends upon your plant configuration.

## 4.3 Controller settings

Views or configures the controller parameter settings.



No.	Item	Use	Notes
1	Return		 Returns to previous display.
2	Search		 Opens search keyboard.
3	Filter groups		 Opens groups of parameters.
4	Refresh		 Reloads the list.
5	Controller Settings List		Scrolls settings up or down on this page.
6	Clear filter group		Clears the filter group (if used).
7	Scroll page		 Scrolls the page left.  Scrolls the page right.
8	Edit		 Edits the setting.
9	Enabled status	-	Shows the status of the setting.  Not enabled.  Enabled.











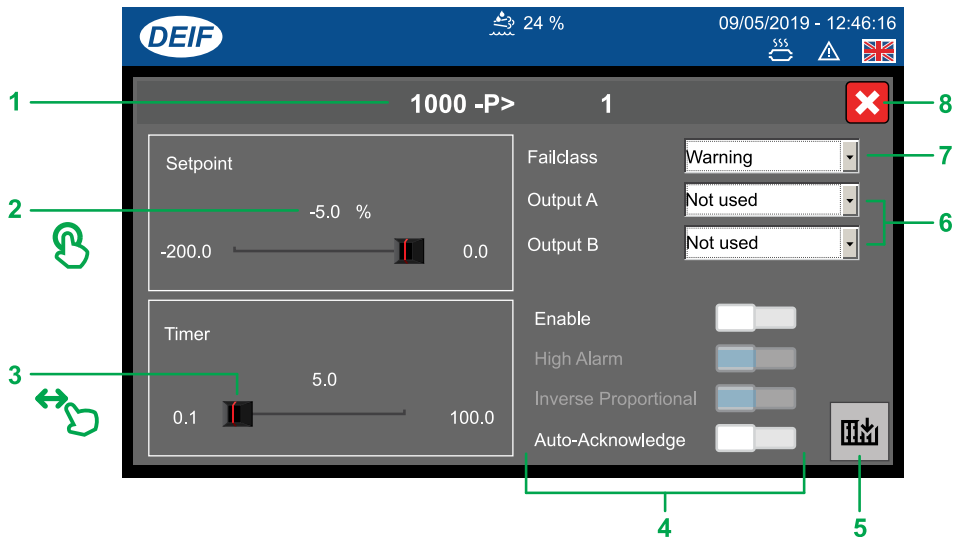







### More information

\* See **Password levels** in the chapter **User Permissions** for more information about the different password levels.

### 4.3.1 Edit settings

Edits the controller setting that was selected. \*





No.	Item	Use	Notes
1	Setting	-	Shows the name of the setting.
2	Value		Shows the value of the setting. Opens the Value keyboard to edit value. *
3	Value (Scroll)		 Scrolls left or right to increase or decrease the value.
4	Settings	-	Toggles on or off additional settings.
		 or 	 Setting enabled.
		 or 	 Setting disabled.
5	Write		 Writes the settings to the controller.
6	Output		Selects an output terminal.
7	Failclass		Selects a Failclass.
8	Cancel		 Cancels the changes.

**NOTE** \* The actual controller settings shown depend upon the type of setting that you are configuring.

## 4.3.2 Filter groups

Lists the filter groups you can use to filter the controller settings page.









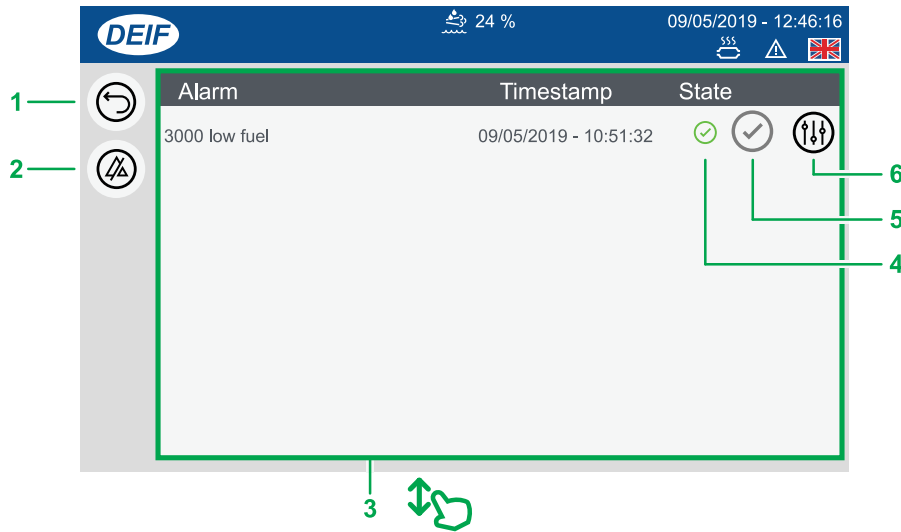



No.	Item	Use	Notes
1	Filter groups		Shows the list of filter groups.
			Selects a filter group.
		 	Returns to previous display.

## 4.4 Alarms

Views or acknowledges any alarms created in the system.











No.	Item	Use	Notes
1	Back		 Returns to previous display.
2	Acknowledge all alarms		 Acknowledges all unacknowledged alarms.
3	Alarms list		Scrolls the alarm list up or down.
4	Alarm state	-	Shows the state of the alarm.
			 Acknowledged alarm.  Unacknowledged alarm.
5	Acknowledge		 Acknowledges alarm.
6	Alarm settings		 Opens the alarm configuration.



## 4.4.1 Alarms popup

New alarms activated in the system are shown on the alarms popup at the top of the display.









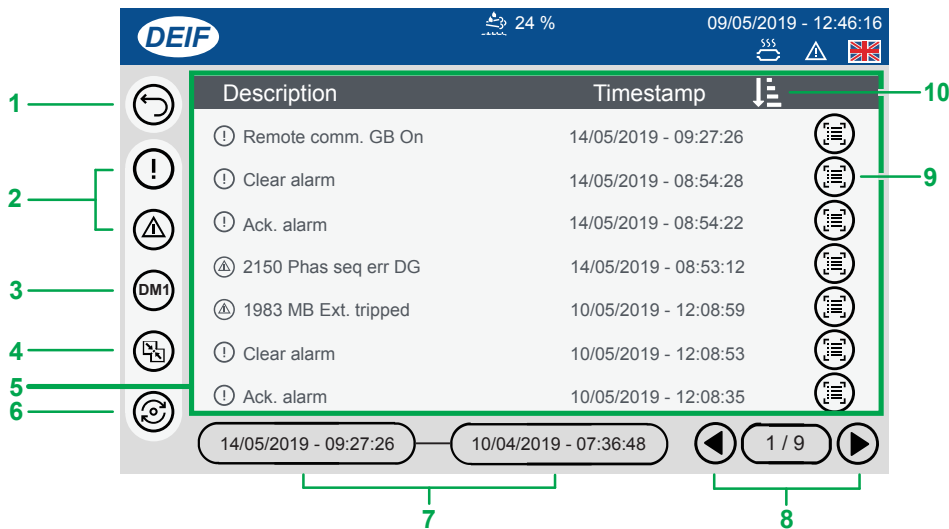













No.	Item	Use	Notes
1	Alarm	-	Shows the activated alarm.
2	Alarms list		 Opens the Alarms list (shortcut).
3	Alarm settings		 Opens the Alarm settings (shortcut).
4	Acknowledge		 Acknowledges the alarm (Shortcut).
5	Cancel		 Cancels the pop up message.

## 4.5 Logs

Shows the list of all recorded events or alarms created in the system. You can also filter, merge, or view further details on the events.









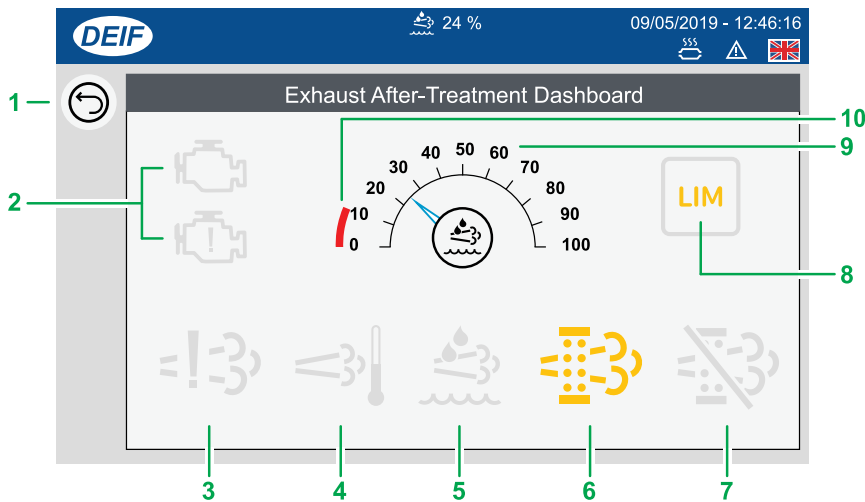



No.	Item	Use	Notes
1	Return		 Returns to previous display.
2	Filter		Filters the list by either Alarms or Events only.
			 Shows only Alarms.  Shows only Events.
3	DM1 EIC alarm list		 Shows the list of active alarms from the engine control unit.
4	Merge list		 Merges the list to show both Alarms and Events.
5	Refresh		 Refreshes the log list.
6	Log list		Scrolls the log list up or down.
7	Page range	-	Shows the date range of the list page shown.
8	Scroll page		 Scrolls the page left.
			 Scrolls the page right.
9	Event details		 Shows the event details.
10	Sort page		 Sorts the page Ascending order.
			 Sorts the page Descending order.

## 4.6 Exhaust After-Treatment Dashboard (Tier4)

Shows information about the Exhaust After-Treatment system. \*



No.	Item	Use	Notes
1	Return		 Returns to previous display.
2	Engine interface status	-	 Shows the engine status.
		-	 Shows an engine warning.
-		-	 Shows an engine shutdown.
3	Engine emission system failure	-	 Shows an emission failure or malfunction.
4	High temperature - Regeneration	-	 Shows a high temperature and regeneration is in process.
5	Diesel Exhaust Fluid (DEF)	-	 Shows the level is too low.
6	Diesel Particle Filter (DPF)	-	 Shows that a regeneration is needed.
7	Diesel Particle Filter (DPF) Inhibit	-	 Shows that regeneration is inhibited.
8	LIM **	-	LIMIT lamp
9	Diesel Exhaust Fluid (DEF) % level	-	Shows the level (%) of the Diesel Exhaust Fluid.
10	Minimum DEF % level	-	Shows the minimum low level for the Diesel Exhaust Fluid.

Grey symbols (Example: ) show that communication for the item is available. Not all types of engines support all items shown.

**NOTE** \* This page is only available if engine communication is configured on the system.

**NOTE** \*\* Only for MTU engines.







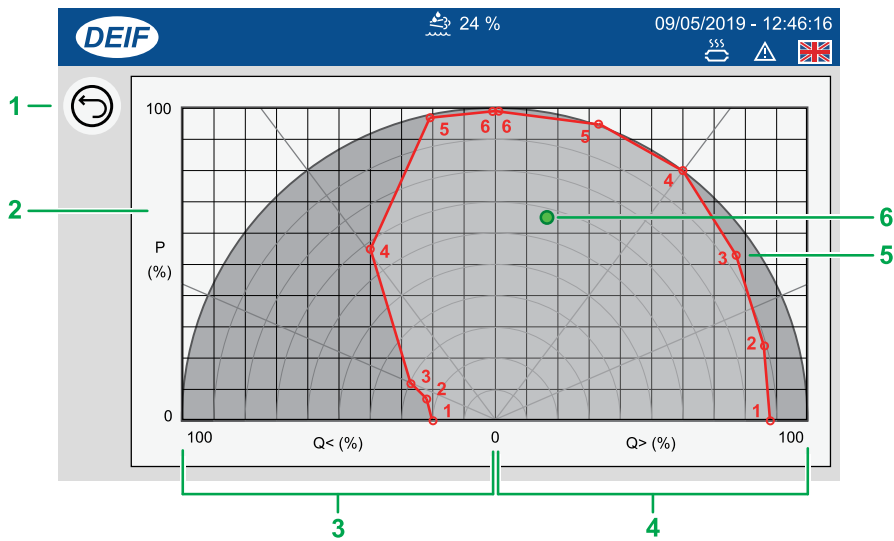

### More information

See **Display Config > More Settings** for more information about automatically displaying this page if an alarm becomes active.

## 4.7 Alternator curve

Views or configures the safe operation limits for the alternator. \*











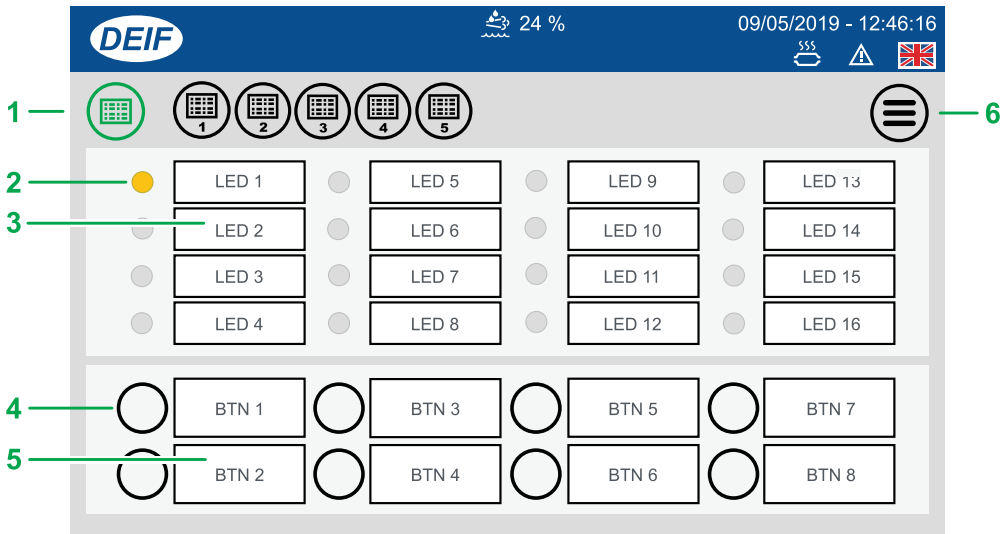





No.	Item	Use	Notes
1	Return		 Returns to previous display.
2	Alternator curve	-	Shows the safe operation limits for the alternator.
3	Import (Leading)		Opens the capacitive Q< configuration.
4	Export (Lagging)		Opens the inductive Q> configuration.
5	Setting point	-	Shows the numbered setting points.
6	Actual working point	-	 Shows the GENSETs actual working point.

**NOTE** \* For AGC-4, option C2 is required to see the operation limits.

## 4.8 Additional Operator Panel (AOP)

Additional Operator Panels (AOPs) provide you with LED indication and button actions. You can configure the LED or button labels directly on the display, but the functionality behind them must be configured in your M-Logic project on the utility software. \*



No.	Item	Use	Notes	
1	Panel selection		Tap to select the panel to display.	
2	LED status		Shows the LED status from the M-Logic project condition(s). *	
			 Green.	 Green + blink.
			 Yellow.	 Yellow + blink.
			 Red.	 Red + blink.
3	LED name		Edits the LED name. **	
4	Button		 Operates the button (if configured).	
5	Button name		Edits the button name. **	
6	Menu		 Opens the menu page.	

**NOTE** \* The logic condition(s) must be configured in your M-Logic project for the LED status and buttons to work.

**NOTE** \*\* LED name and button name are saved locally on the TDU 107.







### More information

See **Application notes M-Logic AGC-4 Mk II** for more information about how to create and configure M-Logic projects.

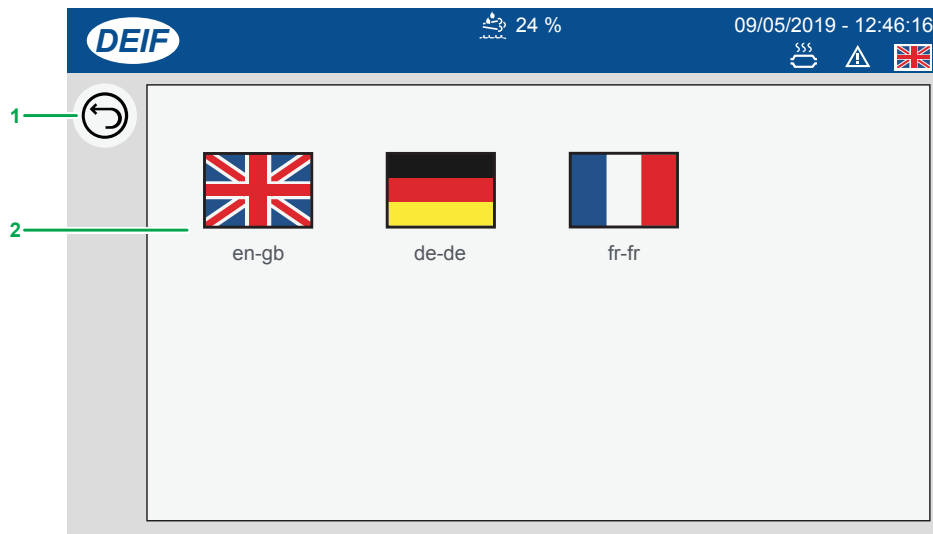
## 4.9 Language

Selects an active language for the display. \*



No.	Item	Use	Notes
1	Return		 Returns to previous display.
2	Languages *	-	Shows the available active languages.
			Selects the language for the display.

**NOTE** \* The actual languages shown must be both installed and active to be listed for selection.











### More information

See **Language Mgt** for more information about how to make languages active or hidden.

## 4.10 User permissions

### 4.10.1 Password levels





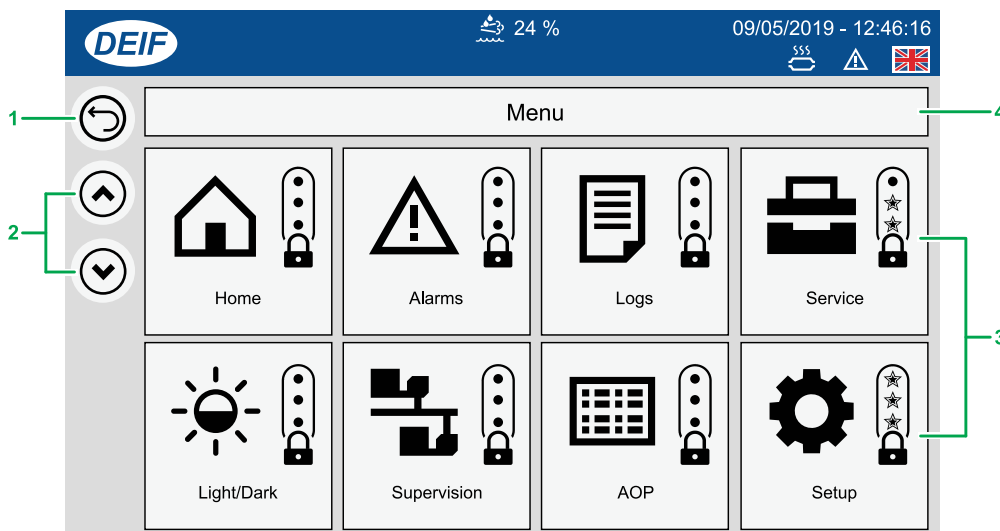

Table 4.1 Password level symbols

Symbol	Password level	Symbol	Password level
 or 	No login required	 or 	Level 1 - Customer
 or 	Level 2 - Service	 or 	Level 3 - Master

### 4.10.2 User permissions

Features of the display can be restricted to the AGC password levels.



No.	Item	Use	Notes
1	Return		 Returns to previous display.
2	Scroll page		 Scrolls page up.  Scrolls page down.
3	Feature permissions		Toggles through the password levels.
4	Page	-	Shows the page group name.









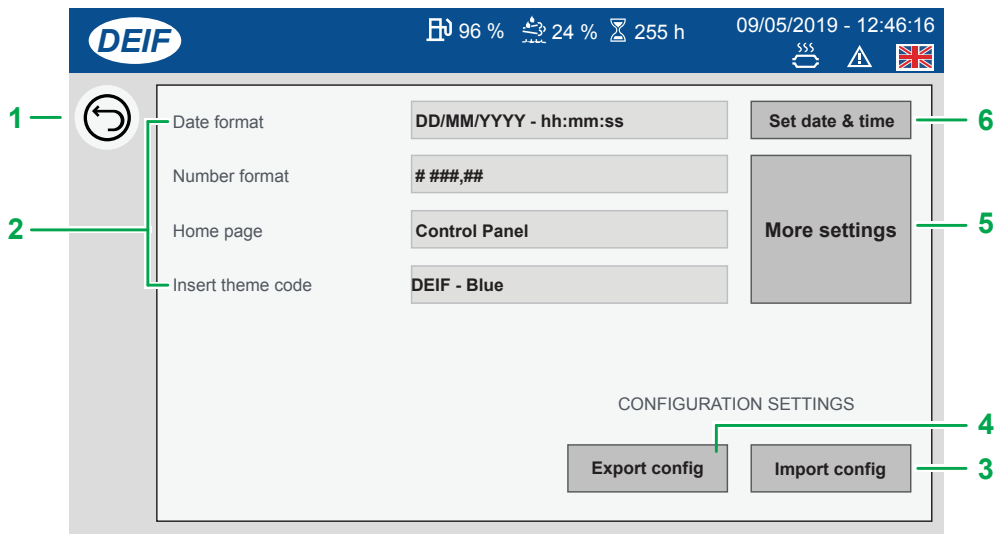

#### More information

See **Display settings** for more information about how to change the default Home page.

## 4.11 Display Config

Views or configures the display settings.



No.	Item	Use	Notes
1	Return		 Returns to previous display.
2	Display settings		Edits the display settings: <ul style="list-style-type: none"> <li>• Data and time format</li> <li>• Number format</li> <li>• Default Home page</li> <li>• Theme code name</li> </ul>
			Edits the date and time format for the display.
3	Import configuration		Imports a configuration from a USB drive.
4	Export configuration		Exports the configuration to a USB drive.
5	More settings		Opens the more settings page.
6	Set data and time		Sets the date and time from the entered value.



## 4.11.1 More settings

Views or configures the additional settings for the display.

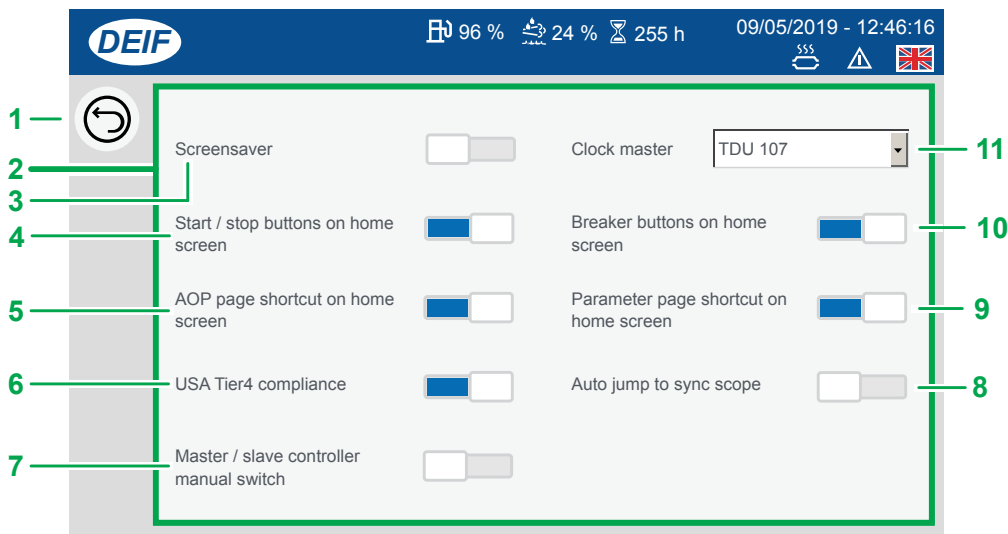

No.	Item	Use	Notes
1	Return		Returns to previous display.
2	Settings	-	Toggles on or off additional settings.
		or	Setting enabled. Setting disabled.
3	Screensaver	or	Enables or disables the screensaver.
4	Start / Stop buttons	or	Shows or hides the start / stop buttons on the home page.
5	AOP shortcut	or	Shows or hides the AOP button on the home page.
6	Tier 4 compliance	or	Enables or disables the Tier 4 compliance. Enable this to automatically display the Exhaust After-treatment Dashboard if an alarm becomes active.
7	Master/slave controller manual switch	or	<b>Enable:</b> There is a redundant AGC. <ul style="list-style-type: none"> <li>Buttons on the <b>Home</b> page show whether the master or slave AGC is the active controller.</li> <li>You can select the master and slave AGC IP addresses on the <b>Setup &gt; Connect to Controller &gt; Communication settings</b> page.</li> </ul> <b>Disable:</b> There is no redundant AGC.
8	Auto jump to sync scope	or	Enables an automatic jump to the synchronisation scope when a breaker is synchronising. After synchronisation the page automatically returns to the control panel.
9	Parameter shortcut	or	Shows or hides the Parameter button on the home page.
10	Breaker buttons	or	Shows or hides the breaker buttons on the home page.
11	TDU 107 clock master		Select the master clock for the system.

## 4.12 🌐 Language Mgt

Manages the language translations available on the display. Only Active languages can be used on the display.

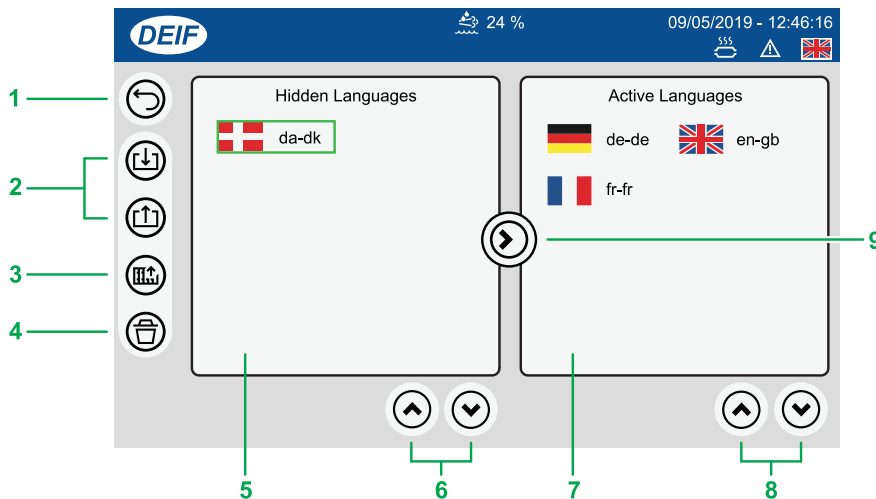

No.	Item	Use	Notes
1	Return		Returns to previous display.
2	Import		Imports all language files present on the USB device.
	Export		Exports the selected language to the USB device.
3	Create language		Creates a new language file to the USB device.
4	Delete		Deletes the selected language file.
5	Hidden language(s) list	-	Shows languages that are hidden from use.
			Selects a language. **
6	Hidden language(s) scroll page	Scrolls page up.  Scrolls page down.	
7	Active language(s) list	-	Shows languages that are active for use.
			Selects a language. **
8	Active language(s) scroll page	Scrolls page up.  Scrolls page down.	
9	Move selected language	-	Moves the selected language file.
		Move to Hidden. ***  Move to Active	

**NOTE** \* Grey symbols (Example: ) show that an option is not possible. For example, you can only delete a language if you have selected a language first.

**NOTE** \*\* Selected languages are marked with a green outline box.

**NOTE** \*\*\* It is not possible to hide the currently active language.

## 4.13 Language translations

### 4.13.1 Introduction

You can create your own language translation files for use with your TDU 107 and AGC.

**NOTE** If you have already edited your own translated language(s) files on your AGC, these are included in the create function. You will then only need to edit the TDU 107 specific texts. All previously translated texts for your AGC are included in the extracted language file.



#### How to do translations

See our tutorial on [How to translate texts](#) for help and guidance.

### 4.13.2 Before you begin

DEIF recommends that you read the following notes before attempting to create or edit language files.

#### Required tools

- USB drive (FAT32)
  - To import/export the file(s) to your PC.
  - Must be formatted for FAT32 file system to be recognised by the TDU 107.
- Notepad++
  - To edit the language file(s).

#### Language files

The language files have a required structure for them to work correctly with your TDU 107.



- Each language file is a comma-separated file (.csv) using the semi-colon (;) as the delimiter.
  - Make sure all entries keep the delimiter (;).
  - It is important that the format and structure of the file entries remain the same.
- TDU 107 specific entries, that is to say, for the display screen, all start with a hash (#).
- The first set of texts are for TDU 107. The second set of texts are for the AGC.
- The default master filename is **ma-ma.csv**.
  - You should rename this file to your required language name.
    - For example, for British English: **en-gb.csv**.
- The file is formatted using UTF-8, in UNIX format.
  - DEIF recommend using Notepad++ to edit your translation files.
  - Do not use a typical windows spreadsheet application, such as Excel, to edit or save the file. This will change the formatting in the file and it will no longer be recognised correctly by the TDU 107.
- The language and country is configured by using the standard ISO codes.
  - **Language:** ISO639-1
    - See: [https://en.wikipedia.org/wiki/List\\_of\\_ISO\\_639-1\\_codes](https://en.wikipedia.org/wiki/List_of_ISO_639-1_codes) (Provided in English)
  - **Country:** ISO3166-1 (Alpha-2)
    - See: [https://en.wikipedia.org/wiki/ISO\\_3166-1\\_alpha-2](https://en.wikipedia.org/wiki/ISO_3166-1_alpha-2) (Provided in English)

**NOTE** The TDU 107 only reads the AGC texts at start-up. If you edit the AGC texts in the Utility software, while the TDU is already running, you must restart the TDU 107 to read the new texts.

### 4.13.3 Create or edit language translation

1. Access the language translation feature from:

Home > Setup > Display settings > Language Mgt

2. Select the **Create language** option .
3. You are prompted to insert your USB drive into the USB port.
4. Insert your USB drive into the USB port.
  - It takes a few moments to recognise the USB drive.
  - When recognised a USB icon  is displayed on the status bar.
5. Wait for the USB icon  to be displayed on the status bar.
6. Select confirm to create the language file on the USB drive.
7. Once complete, you can remove the USB drive.
8. Insert your USB drive into your computer.
9. Copy the language file over to your local drive.
10. Rename your file to the language name you wish to create.
11. Open the file for editing with Notepad++.
12. Edit the texts that you wish to change.
13. Save the updated translation file to your USB memory device.
14. Safely remove your USB drive from your PC by using the Eject or similar option.
15. Insert the USB drive into your TDU 107.

- When recognised the TDU displays the USB icon  on the status bar.

16. Open again the **Language Mgt**  page.

- Home > Setup > Display Settings > Language Mgt

17. Select **Import** .

18. Follow the on-screen guide to import your language. Your language now appears in the active list as an active language.

19. Open the **Language**  page.

- Home > Setup > Language

- or use the language flag directly shown on the status bar.

- Example: 

20. Your new language file is shown for selection.
21. Select your new language for your TDU 107 display.
  - The TDU 107 now reloads all the texts after confirmation.

## 4.14 Export or import settings

### 4.14.1 Introduction

You can export or import your TDU 107 configuration to a USB drive. This can be useful for backing up your configuration or transferring the configuration to another TDU 107.

The configuration includes:

- Instrument settings
- Password levels
- Addition Operator Panel (AOP) texts
- All TDU 107 configuration settings

**NOTE** This is not an export or import of the AGC configuration.

### 4.14.2 Before you begin



You will need a USB drive formatted with FAT32 file system to be recognised by the TDU 107.

### 4.14.3 Export or import configuration file

#### Export configuration

1. Access the export feature from:



```
Home > Setup > Display settings > Display config
```

2. Select **Export** option.
  - You are prompted to insert your USB drive into the USB port.
3. Insert your USB drive into the USB port.
  - It takes a few moments to recognise the USB drive.
  - When recognised the USB icon  is displayed on the status bar.
4. Wait for the USB icon  to be displayed on the status bar.
5. Select confirm to start exporting the configuration.
  - During the export a message is displayed.
6. When the export has completed a confirmation message is shown.
7. Select **Confirm** to complete the export.

#### Import configuration

1. Access the import feature from:

```
Home > Setup > Display settings > Display config
```

2. Select **Import** option.
  - You are prompted to insert your USB drive into the USB port.
3. Insert your USB drive into the USB port.
  - It takes a few moments to recognise the USB drive.
  - When recognised the USB icon  is displayed on the status bar.
4. Wait for the USB icon  to be displayed on the status bar.
5. Select confirm to start importing the configuration.
  - During the import a message displayed.
6. When the import has completed a confirmation message is shown.

- The TDU 107 must be restarted for the new configuration to be applied.

7. Select **Confirm** to restart.

## 4.15 Access lock

The TDU 107 supports the Access lock function from the AGC.

When a digital input is configured for this function and is active (high), attempting to operate the TDU 107 displays the Access lock message in the status bar. Configuration and operation can no longer be saved or changed.

Example page with Access lock shown:

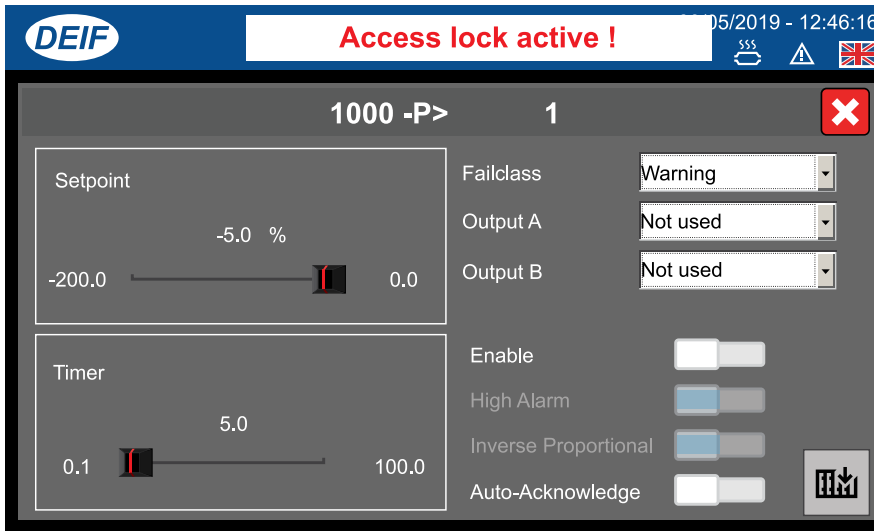

### AGC Access lock

Access lock is configured with the AGC utility software on any digital input.

Example digital input configured with Access lock:

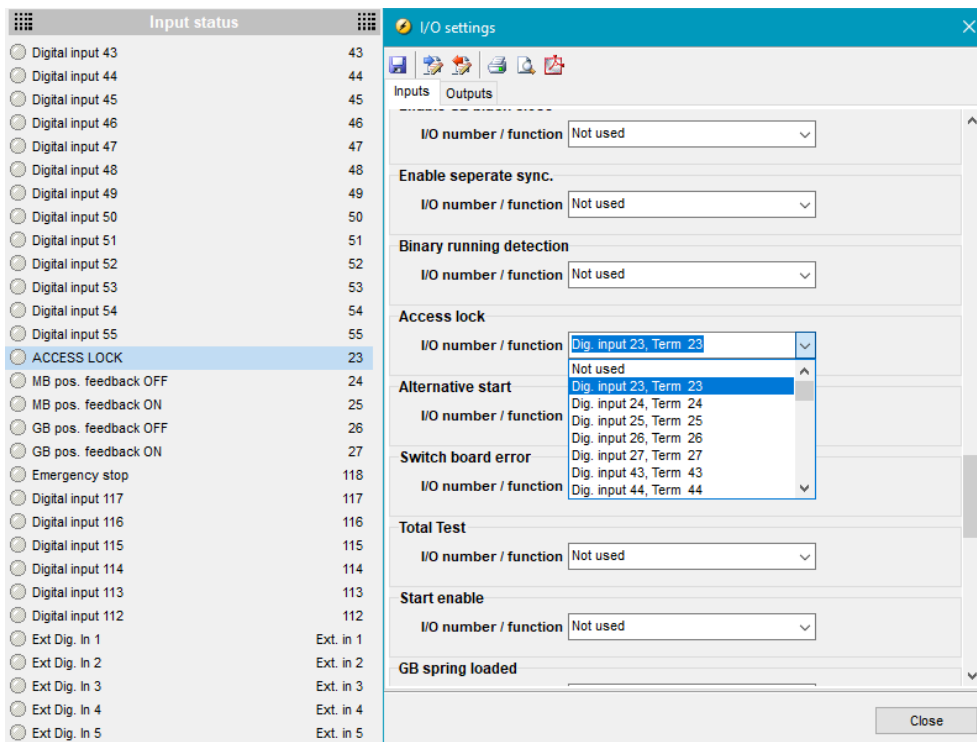

## 5. End-of-life

### 5.1 Disposal of waste electrical and electronic equipment

WEEE symbol

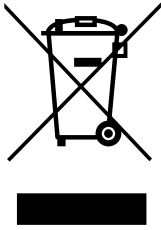

All products that are marked with the crossed-out wheeled bin (the WEEE symbol) are electrical and electronic equipment (EEE). EEE contains materials, components and substances that can be dangerous and harmful to people's health and to the environment. Waste electrical and electronic equipment (WEEE) must therefore be disposed of properly. In Europe, the disposal of WEEE is governed by the WEEE directive issued by the European Parliament. DEIF complies with this directive.

You must not dispose of WEEE as unsorted municipal waste. Instead, WEEE must be collected separately, to minimise the load on the environment, and to improve the opportunities to recycle, reuse and/or recover the WEEE. In Europe, local governments are responsible for facilities to receive WEEE. If you need more information on how to dispose of DEIF WEEE, please contact DEIF.